

Instructions for Use

# Infinity<sup>®</sup> Acute Care System<sup>™</sup>



## **WARNING**

To properly use accessories, read and comply with all relevant Instructions for Use.

## **Monitoring Accessories**

## Working with these Instructions for Use

---

### The title of the main chapter

in the header line helps with orientation and navigation.

### The instructions for the user

combine text and illustrations, providing a comprehensive overview of the system. The information is presented as sequential steps of action, allowing the user to learn directly how to use the device.

### The text

provides explanations and instructs the user step-by-step in the practical use of the product, with short, clear instructions in easy-to-follow sequence.

- 1 Consecutive numbers indicate steps of action, with the numbering restarting with “1” for each new sequence of actions.
- Bullet points indicate individual actions or different options for action.
- Dashes indicate the listing of data, options or objects.

### The illustrations

establish the relationship between the text and the device. Elements mentioned in the text are highlighted. Unnecessary details are omitted.

Schematic renderings of screen images guide the user and allow to reconfirm actions performed. The actual screen images differ in look or in configuration.

**A** Letters denote elements referred to in the text.

### Typing conventions in this manual

Any text shown on the screen is printed in bold and italics, e.g. ***PEEP***, ***Air*** or ***Alarm Settings***.

## Trademarks

---

- Infinity®
- Acute Care System
- Hemo4®
- Hemo2®
- MPod®
- MCable™
- MonoLead®

are trademarks of Dräger.

- Rainbow®
  - Masimo®
  - Masimo SET® (Signal Extraction Technology)
- are registered trademarks of Masimo Corporation.

- Nellcor®
- OxiMax®
- OxiBand™
- Durasensor™

are trademarks of Nellcor Puritan Bennett, LLC.

## Definitions

---

### **WARNING**

**A WARNING statement provides important information about a potentially hazardous situation which, if not avoided, could result in death or serious injury.**

### **CAUTION**

A CAUTION statement provides important information about a potentially hazardous situation which, if not avoided, may result in minor or moderate injury to the user or patient or in damage to the equipment or other property.

### **NOTE**

A NOTE provides additional information intended to avoid inconveniences during operation.

This page intentionally left blank

# Contents

---

<b>Contents</b> .....	5
<b>For Your Safety and that of Your Patients</b> ..	7
<b>List of Accessories</b> .....	9
Infinity Acute Care System accessories	
overview .....	10
General IACS accessories .....	13
IACS Options .....	14
ECG monitoring – reusable leadsets .....	15
ECG monitoring – single-patient use leadsets .	16
ECG monitoring – MonoLeads .....	17
ECG monitoring – neonatal .....	18
Invasive blood pressure (IBP) with Hemo2	
Pod or Hemo4 Pod .....	19
IBP monitoring with MPod – QuadHemo or	
MCable – Dual Hemo .....	20
Non-invasive blood pressure (NIBP)	
monitoring – Dräger connectors .....	21
Non-invasive blood pressure (NIBP)	
monitoring – neonatal .....	23
Pulse oximetry (SpO <sub>2</sub> ) monitoring – Masimo	
Rainbow SET (LNCS) .....	24
Pulse oximetry (SpO <sub>2</sub> ) monitoring – Masimo	
Rainbow SET .....	25
Pulse oximetry (SpO <sub>2</sub> ) monitoring – Nellcor	
OxiMax .....	26
Cardiac output monitoring .....	27
CO <sub>2</sub> monitoring .....	28
Temperature monitoring .....	29
MCable - Analog/Sync .....	32

This page intentionally left blank

## **For Your Safety and that of Your Patients**

---

Strictly follow these Instructions for Use . . . . .	8
General precaution . . . . .	8
Training . . . . .	8
Sterile accessories . . . . .	8

## Strictly follow these Instructions for Use Training

### WARNING

To maintain patient safety, adhere to all **WARNINGS** and **CAUTIONS** on equipment labels or appearing in the Instructions for Use for the Infinity Acute Care System (IACS) applications.

Training for users is available from the responsible Dräger organization. See [www.draeger.com](http://www.draeger.com) for more information.

## Sterile accessories

### CAUTION

Read all cleaning instructions (for example, originating from the disinfectant manufacturer and the hospital) carefully *before* cleaning the device. Refer to the chapter entitled "Cleaning" for device-specific cleaning instructions in the Infinity Acute Care System M540 Instructions for Use.

### CAUTION

Do not use sterile-packaged accessories if the packaging has been opened, is damaged or there are other signs of non-sterility. Disposable articles must not be reprocessed and resterilized. Reuse, reprocessing, or resterilization can lead to a failure of the medical device and cause injury to the patient.

## General precaution

### CAUTION

Even accessories designed to be reused have a limited service life. Handling and reprocessing can increase wear and markedly shorten service life (e.g., disinfectant residues can attack the material more intensely during autoclaving). If signs of wear become visible, such as cracks, deformation, discoloration, peeling, etc., affected accessories must be replaced.



## List of Accessories







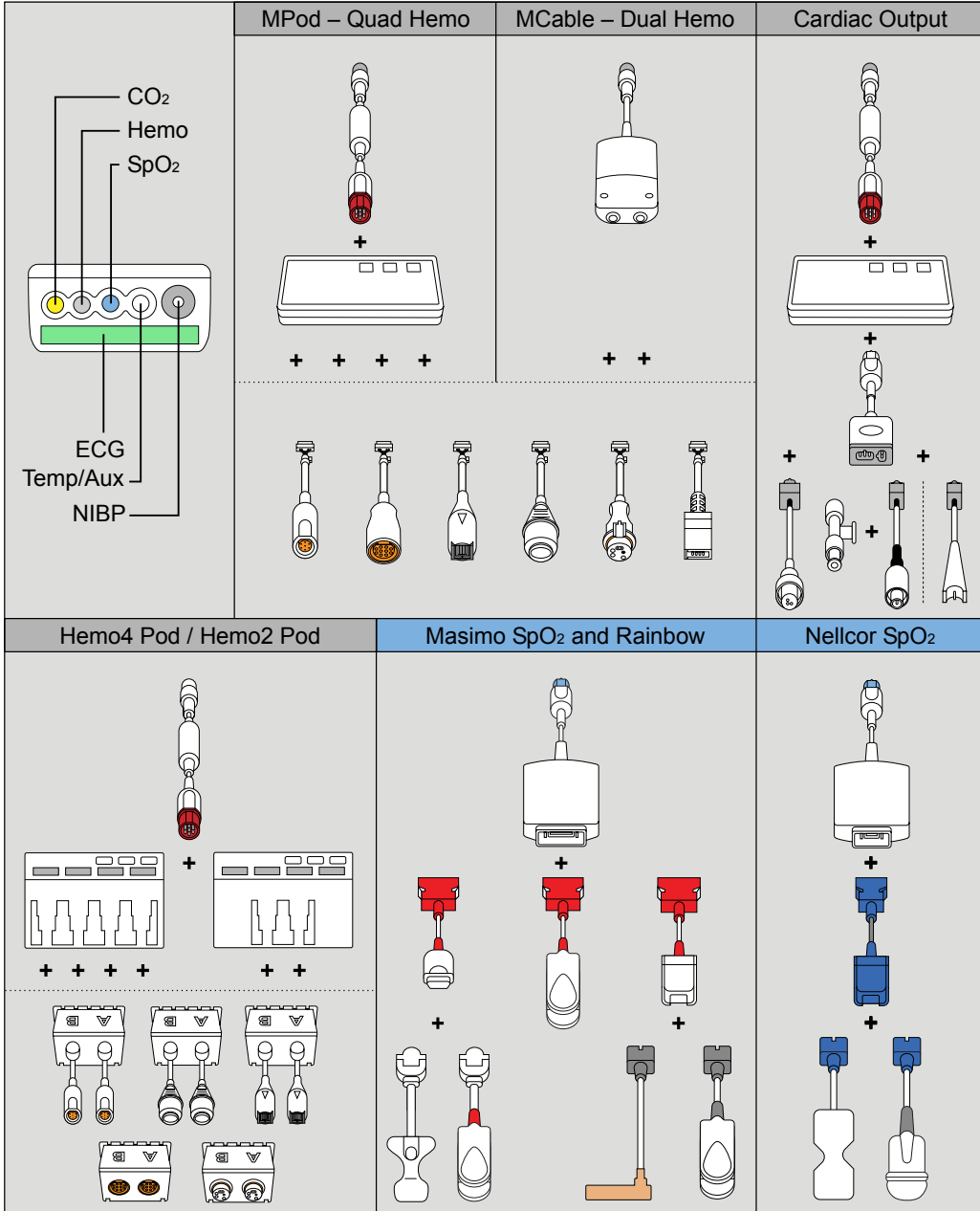



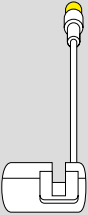

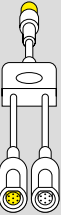

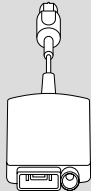
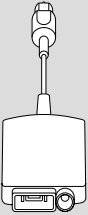





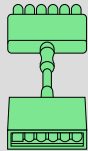
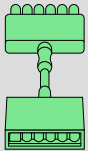
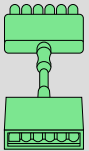
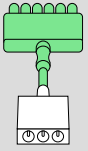

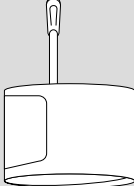
<b>Infinity Acute Care System accessories overview</b> . . . . .	10	<b>Non-invasive blood pressure (NIBP) monitoring – neonatal</b> . . . . .	23
<b>General IACS accessories</b> . . . . .	13	NIBP hose . . . . .	23
System components . . . . .	13	Single-patient use neonatal NIBP cuffs . . . . .	23
Cables and mouse . . . . .	13	<b>Pulse oximetry (SpO<sub>2</sub>) monitoring – Masimo Rainbow SET (LNCS)</b> . . . . .	24
Keyboards . . . . .	13	Masimo SpO <sub>2</sub> cables . . . . .	24
Miscellaneous hardware . . . . .	13	Masimo single-patient use LNCS sensors . . . . .	24
Mounts for workstation . . . . .	14	Masimo reusable LNCS sensors . . . . .	24
Mounts for power supply . . . . .	14	Masimo SpO <sub>2</sub> accessories (not shown) . . . . .	25
Mounts for the Cockpit and M500/M540 . . . . .	14	<b>Pulse oximetry (SpO<sub>2</sub>) monitoring – Masimo Rainbow SET</b> . . . . .	25
<b>IACS Options</b> . . . . .	14	<b>Pulse oximetry (SpO<sub>2</sub>) monitoring – Nellcor OxiMax</b> . . . . .	26
C700 and C500 options . . . . .	14	Nellcor SpO <sub>2</sub> cables . . . . .	26
<b>ECG monitoring – reusable leadsets</b> . . . . .	15	Nellcor single-patient use sensors . . . . .	26
<b>ECG monitoring – single-patient use leadsets</b> . . . . .	16	Nellcor reusable sensor . . . . .	26
<b>ECG monitoring – MonoLeads</b> . . . . .	17	<b>Cardiac output monitoring</b> . . . . .	27
ECG accessories . . . . .	17	C.O. cables, catheters, and thermistors . . . . .	27
MonoLeads . . . . .	17	Cardiac output kits (not shown) . . . . .	27
<b>ECG monitoring – neonatal</b> . . . . .	18	<b>CO<sub>2</sub> monitoring</b> . . . . .	28
Neonatal leadsets and accessories . . . . .	18	CO <sub>2</sub> cables . . . . .	28
<b>Invasive blood pressure (IBP) with Hemo2 Pod or Hemo4 Pod</b> . . . . .	19	Disposable airway adapters . . . . .	28
IBP pods and cables . . . . .	19	Reusable airway adapters . . . . .	28
Transducer adapter cables . . . . .	19	Additional accessories (not shown) . . . . .	28
<b>IBP monitoring with MPod – QuadHemo or MCable – Dual Hemo</b> . . . . .	20	<b>Temperature monitoring</b> . . . . .	29
IBP cables . . . . .	20	Temperature cables . . . . .	29
Transducer adapter cables . . . . .	20	Skin probes . . . . .	29
<b>Non-invasive blood pressure (NIBP) monitoring – Dräger connectors</b> . . . . .	21	Temperature cables . . . . .	30
NIBP hose . . . . .	21	General purpose probes . . . . .	30
Reusable adult/pediatric NIBP cuffs . . . . .	21	<b>MCable - Analog/Sync</b> . . . . .	32
Single-patient use adult/pediatric NIBP cuffs . . . . .	22	Analog/sync cables . . . . .	32

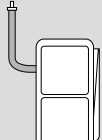
## Infinity Acute Care System accessories overview

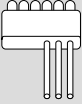
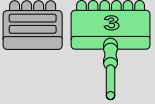
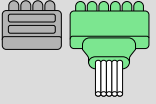
The following diagram is an overview of the accessories available with the Infinity Acute Care System.

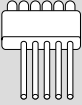
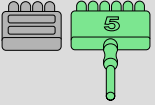
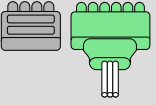
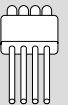

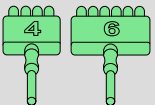
0086

CO <sub>2</sub>		CO <sub>2</sub> & Analog/Sync		Analog & Sync		Temp			
 <p style="text-align: center;">+</p> <div style="display: flex; justify-content: space-around;"> <div style="text-align: center;">  <p>Pediatric</p> </div> <div style="text-align: center;">  <p>Adult</p> </div> </div>		 <p style="text-align: center;">+      +</p> <div style="display: flex; justify-content: space-around;"> <div style="text-align: center;">  <p>CO<sub>2</sub></p> </div> <div style="text-align: center;">  <p>Analog/Sync</p> </div> </div>		 <p style="text-align: center;">+      +</p> <div style="display: flex; justify-content: space-around;"> <div style="text-align: center;">  </div> <div style="text-align: center;">  </div> </div>		 <p style="text-align: center;">+      +</p> <div style="display: flex; justify-content: space-around;"> <div style="text-align: center;">  </div> <div style="text-align: center;">  </div> </div> <p style="text-align: center;">+</p> <div style="text-align: center;">  </div>			
ECG - Reusable		ECG - MonoLead		ECG - Single-Use		ECG - Neo		NIBP	
						 <p style="text-align: center;">+</p> 		<div style="display: flex; justify-content: space-between;"> <div style="text-align: center;"> <p>Adult/Child</p>  <p style="text-align: center;">+</p>  </div> <div style="text-align: center;"> <p>Neonatal</p>  <p style="text-align: center;">+</p>  </div> </div>	
 									
 									
 		 							

087

This chapter lists the accessories available with the Infinity Acute Care System (IACS).

The chapter is divided into the following sections:

- "General IACS accessories" on page 13
- "IACS Options" on page 14
- "ECG monitoring – reusable leadsets" on page 15
- "ECG monitoring – single-patient use leadsets" on page 16
- "ECG monitoring – MonoLeads" on page 17
- "ECG monitoring – neonatal" on page 18
- "Invasive blood pressure (IBP) with Hemo2 Pod or Hemo4 Pod" on page 19
- "IBP monitoring with MPod – QuadHemo or MCable – Dual Hemo" on page 20
- "Non-invasive blood pressure (NIBP) monitoring – Dräger connectors" on page 21
- "Non-invasive blood pressure (NIBP) monitoring – neonatal" on page 23
- "Pulse oximetry (SpO<sub>2</sub>) monitoring – Masimo Rainbow SET (LNCS)" on page 24
- "Pulse oximetry (SpO<sub>2</sub>) monitoring – Masimo Rainbow SET" on page 25
- "Pulse oximetry (SpO<sub>2</sub>) monitoring – Nellcor OxiMax" on page 26
- "Cardiac output monitoring" on page 27
- "CO<sub>2</sub> monitoring" on page 28
- "Temperature monitoring" on page 29
- "MCable - Analog/Sync" on page 32

On the following pages, each parameter section includes a diagram depicting parameter-specific accessories, along with one or more tables displaying accessory names and part numbers. The letters displayed in the diagrams correspond to the letters in the tables. Because some accessories are too numerous to list in the diagram, they do not have a letter associated with them.

Part numbers are subject to change without prior notice. Contact your Dräger representative for the most current part numbers.

Failure to use Dräger-approved accessories may compromise the proper functioning of the IACS.

## General IACS accessories

The following table lists the system components, power cables, system cables, and keyboards for the IACS.

### System components

The following parts are components in the IACS system. They are not available for purchase individually. Contact your Dräger representative for additional information.

Part	Part number
Infinity M500	MS20407
Infinity M540	MS20401
Infinity P2500	MS22277
Infinity PS50	8416800

### Cables and mouse

Part	Part number
Mouse	MS23352
Mouse pad	MS24519
System cable, 1.5 m (4.9 ft)	MS20135
System cable, 4.5 m (14.7 ft)	MS20614
System cable, M540 – PS50	MS20345
System cable, 2.2 m (7.2 ft) <i>(Note that this cable is only to be used in combination with Zeus IE)</i>	MK04408
Ethernet patch cable, 4.9 m (16.1 ft)	4726399
Ethernet cables, 2.4 m (7.9 ft)	4726381
Ethernet cables, 1.2 m (3.9 ft)	4726373
Nurse Call cable	8417370
Export Protocol cable	MS22948

### Keyboards

Part	Part number
Standard keyboard (Russian)	MS24520
Washable keyboard (Czech)	MS22286
Washable keyboard (Denmark)	MS20790
Washable keyboard (English)	MS22288
Washable keyboard (French)	MS22295
Washable keyboard (German)	MS22287
Washable keyboard (Greek)	MS23692
Washable keyboard (Hungarian)	MS22282
Washable keyboard (Italian)	MS22283
Washable keyboard (Norwegian)	MS22284
Washable keyboard (Polish)	MS22290
Washable keyboard (Portuguese)	MS22291
Washable keyboard (Spanish)	MS22294
Washable keyboard (Swedish/Finnish)	MS22285
Washable keyboard (Dutch)	MS23338
Washable keyboard (Turkish)	MS22292

### Miscellaneous hardware

Part	Part number
Transport dock and clamp	MS28144
Cable hook	MS26297
SpO <sub>2</sub> pod mount	MS26266

## Mounts for workstation

Part	Part number
Mount for workstation	MS17139
Mount bracket rail GCX	MS15934

## Mounts for power supply

Part	Part number
Wall mount adapter CPS/IDS power supply	4720061
Rail mount for CPS/IDS power supply	4720095
Wall bracket CPS/IDS power supply	4720129
Power supply rollstand bracket CPS/IDS	4720103

## Mounts for the Cockpit and M500/M540

Part	Part number
Dräger Lift arm front rail - VESA, +300	G96548
Dräger Double arm - front rail - VESA	G96715

## IACS Options

---

The following table lists the locked IACS options that must be purchased and enabled separately. The menu selections on the M540 or the C700/C500 will not be available until the corresponding options have been enabled.

### C700 and C500 options

Part	Part number
12 channels (C500 only)	MS20505
16 channels	MS20506
Full arrhythmia	MS22225
12-Lead ECG	MS20508
Multi IBP	MS20504
Web enabled layouts	MS20511
Web enabled tabs	MS20512
View editor	MS20515
Physiological calculations	MS20516

## ECG monitoring – reusable leadsets

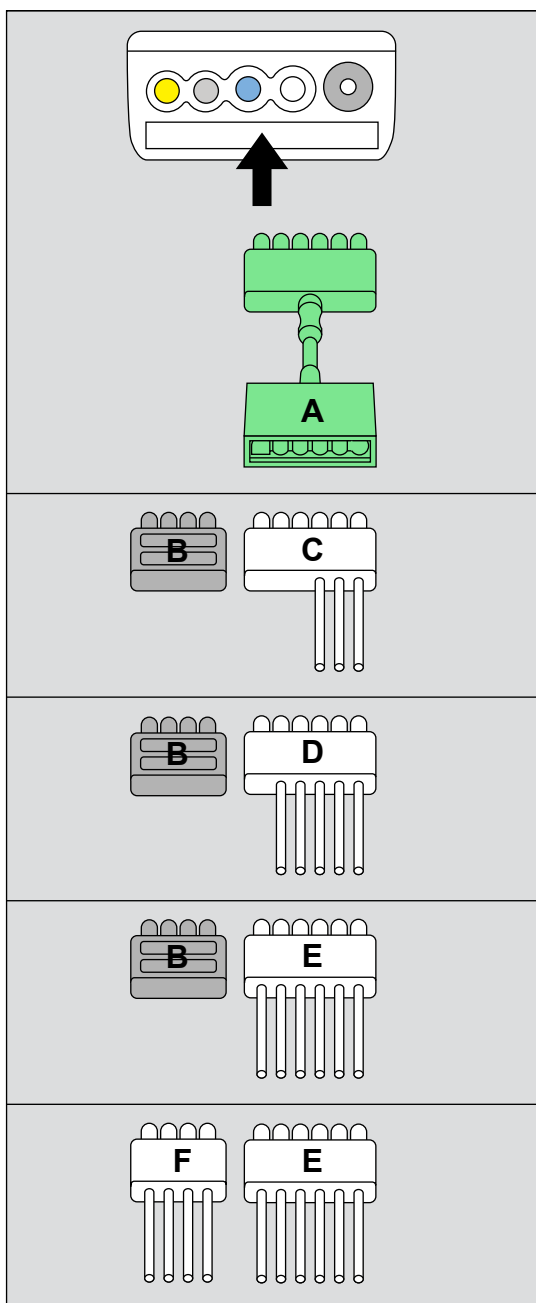

### ECG accessories

	Part	Part number
<b>A</b>	ECG extension cable 3/5/6, 2 m (6.5 ft) <sup>(1)</sup>	MS16256
<b>B</b>	ECG "4-lead" spacer, 10 pieces	MS22832

#### NOTE

<sup>(1)</sup> The extension cable works with MonoLeads and traditional leads. The extension cable is not compatible with ECG 4-lead grabber sets.

### Traditional leadsets

	Part	Part number
<b>C</b>	ECG grabber 3-lead, IEC1 (Europe), 1 m (3.3 ft)	MS16159
	ECG grabber 3-lead, IEC2 (AHA/US), 1 m (3.3 ft)	MS16231
<b>D</b>	ECG grabber 5-lead, IEC1 (Europe), 1 m (3.3 ft)	MS16158
	ECG grabber 5-lead, IEC2 (AHA/US), 1 m (3.3 ft)	MS16546
<b>E</b>	ECG grabber 6-lead, IEC1 (Europe), 1 m (3.3 ft)	MS16157
	ECG grabber 6-lead, IEC2 (AHA/US), 1 m (3.3 ft)	MS16547
<b>F</b>	ECG grabber 4-lead, IEC1 (Europe), 1 m (3.3 ft) <sup>(1)</sup>	MS22365
	ECG grabber 4-lead, IEC2 (AHA/US) 1 m (3.3 ft) <sup>(1)</sup>	MS22364

## ECG monitoring – single-patient use leadsets

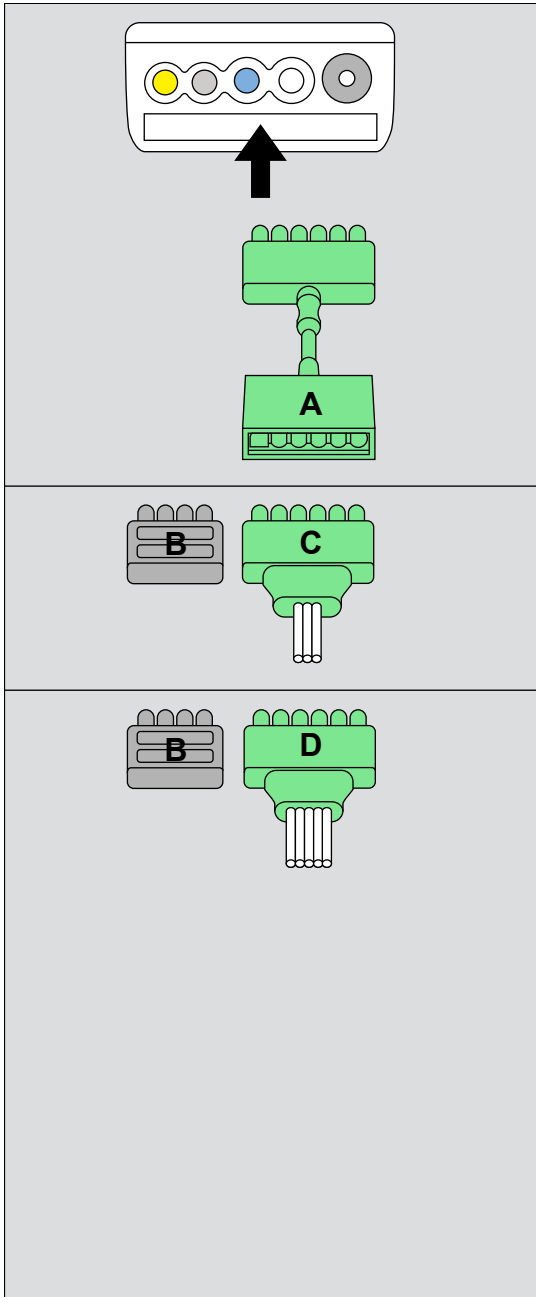

### ECG accessories

	Part	Part number
<b>A</b>	ECG extension cable 3/5/6, 2 m (6.5 ft) <sup>1)</sup>	MS16256
<b>B</b>	ECG "4-lead" spacer, 10 pieces	MS22832

#### NOTE

<sup>1)</sup> The extension cable works with MonoLeads, traditional leads, and single-patient use leads. The extension cable is not compatible with ECG 4-lead grabber sets.

### Traditional leadsets

	Part	Part number
<b>C</b>	ECG grabber 3-lead, IEC1 (Europe), 1 m (3.3 ft)	MP00875
	ECG grabber 3-lead, IEC2 (AHA/US), 1 m (3.3 ft)	MP00877
<b>D</b>	ECG grabber 5-lead, IEC1 (Europe), 1 m (3.3 ft), 1.5 m (4.9 ft)	MP00879
	ECG grabber 5-lead, IEC2 (AHA/US), 1 m (3.3 ft), 1.5 m (4.9 ft)	MP00881

483



## ECG monitoring – MonoLeads

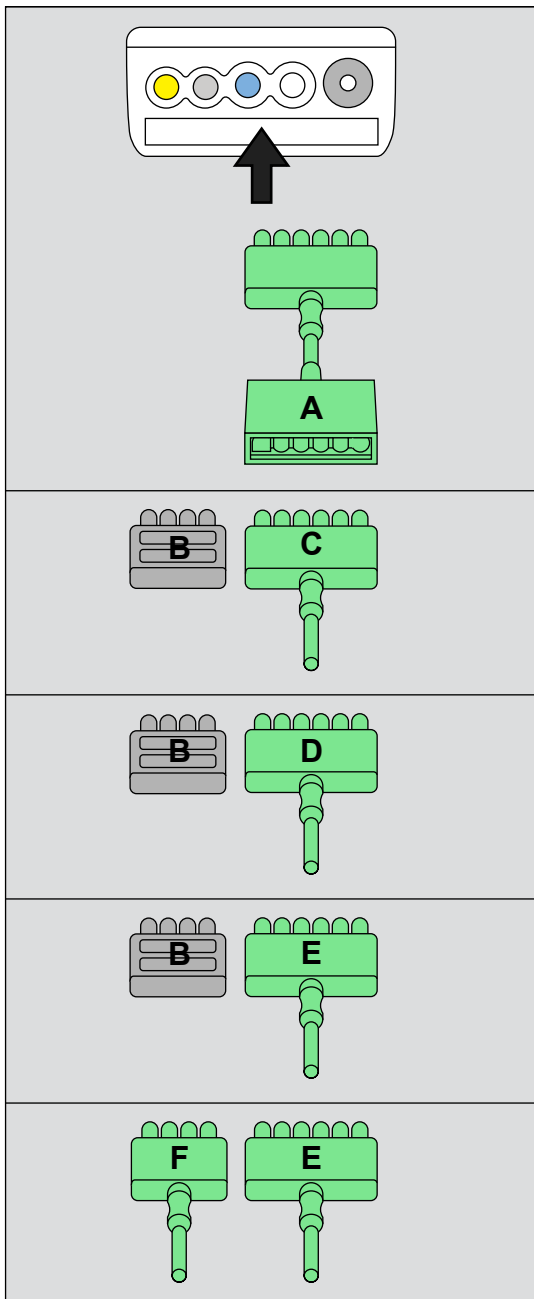

### ECG accessories

	Part	Part number
<b>A</b>	ECG extension cable 3/5/6, 2 m (6.5 ft) <sup>1)</sup>	MS16256
<b>B</b>	ECG "4-lead" spacer, 10 pieces	MS22832

#### NOTE

<sup>1)</sup> The extension cable works with MonoLeads, traditional leads, and single-patient use leads. The extension cable is not compatible with ECG MonoLead 4-lead.

### MonoLeads

	Part	Part number
<b>C</b>	ECG MonoLead 3-lead, IEC1 (Europe), 1 m (3.3 ft)	MS14555
	ECG MonoLead 3-lead, IEC2 (AHA/US), 1 m (3.3 ft)	MS14556
<b>D</b>	ECG MonoLead 5-lead, IEC1 (Europe), 1 m (3.3 ft)	MS14559
	ECG MonoLead 5-lead, IEC2 (AHA/US) 1 m (3.3 ft)	MS14560
<b>E</b>	ECG MonoLead 6-lead, IEC1 (Europe), 1 m (3.3 ft)	MS14683
	ECG MonoLead 6-lead, IEC2 (AHA/US), 1 m (3.3 ft)	MS14682
<b>F</b>	ECG MonoLead 4-lead, IEC1 (Europe), 1 m (3.3 ft)	MS14693
	ECG MonoLead 4-lead, IEC2 (AHA/US), 1 m (3.3 ft)	MS14694
	ECG MonoLead 4-lead, IEC1 (Europe), 3 m (9.8 ft)	MS20476
	ECG MonoLead 4-lead, IEC2 (AHA/US), 3 m (9.8 ft)	MS20475

## ECG monitoring – neonatal

### Neonatal leadsets and accessories

**WARNING**

To prevent burns during electrosurgery (ESU), do not use the ECG neonatal 3-lead adapter cable with the ECG extension cable (MS16256).

	Part	Part number
<b>A</b>	ECG neonatal 3-lead adapter cable, 2 m (6.5 ft), single-pin	MS25951
<b>B</b>	ECG electrode KittyKat 300 pieces	5195024
<b>C</b>	ECG 4-lead spacer, 10 pieces	MS22832

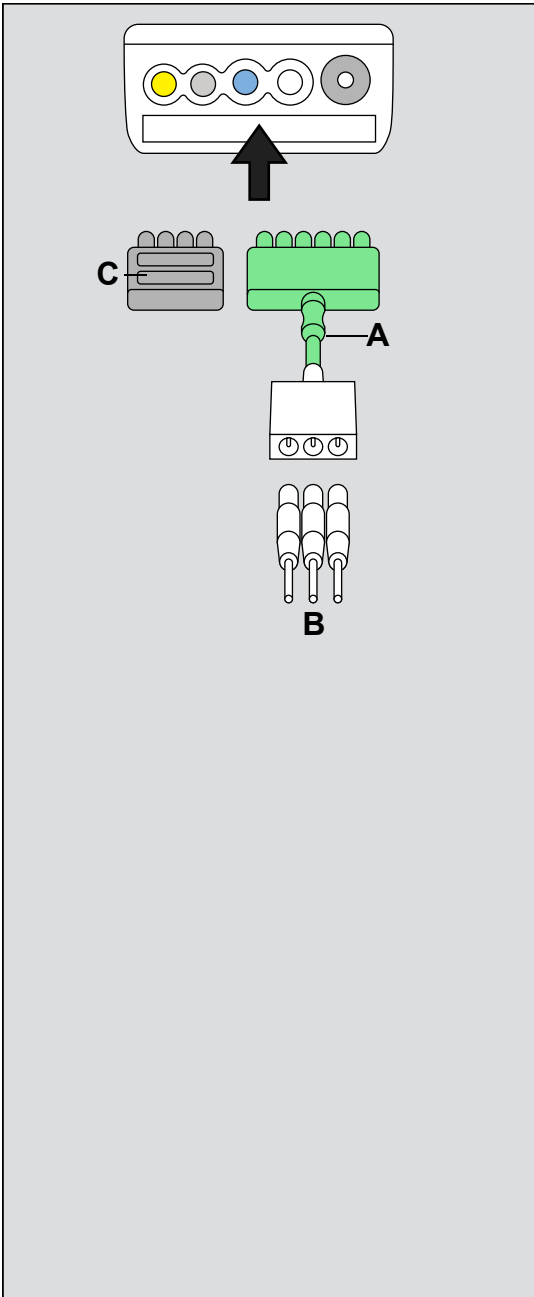

076

## Invasive blood pressure (IBP) with Hemo2 Pod or Hemo4 Pod

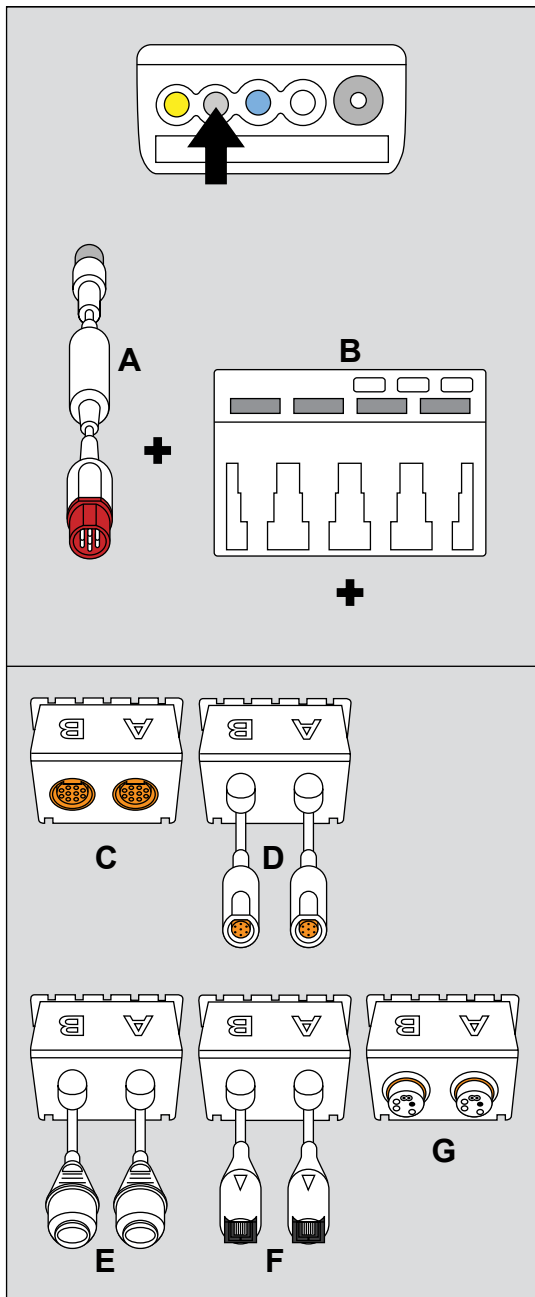

### IBP pods and cables

	Part	Part number
A	M540 Hemo Connect cable, 1.5 m (4.9 ft) <sup>1)</sup>	MS23897
	M540 Hemo Connect cable, 2.9 m (9.5 ft) <sup>1)</sup>	MS23898
B	Hemo2 pod ( <i>not shown</i> )	4319435
	Hemo4 pod	4315961

#### NOTE

<sup>1)</sup> The M540 Hemo Connect cable is used with the Hemo2 pod/Hemo4 pod.

### Transducer adapter cables

	Part	Part number
C	Hemo pod adapter, 10-pin	3375958
D	Hemo pod adapter, SensoNor, 7-pin	MS23598
E	Hemo pod adapter, Baxter-Edwards	5196980
F	Hemo pod adapter, Abbott-Medex	5196998
G	Hemo pod adapter, Becton/Dickinson	3375941

## IBP monitoring with MPod – QuadHemo or MCable – Dual Hemo

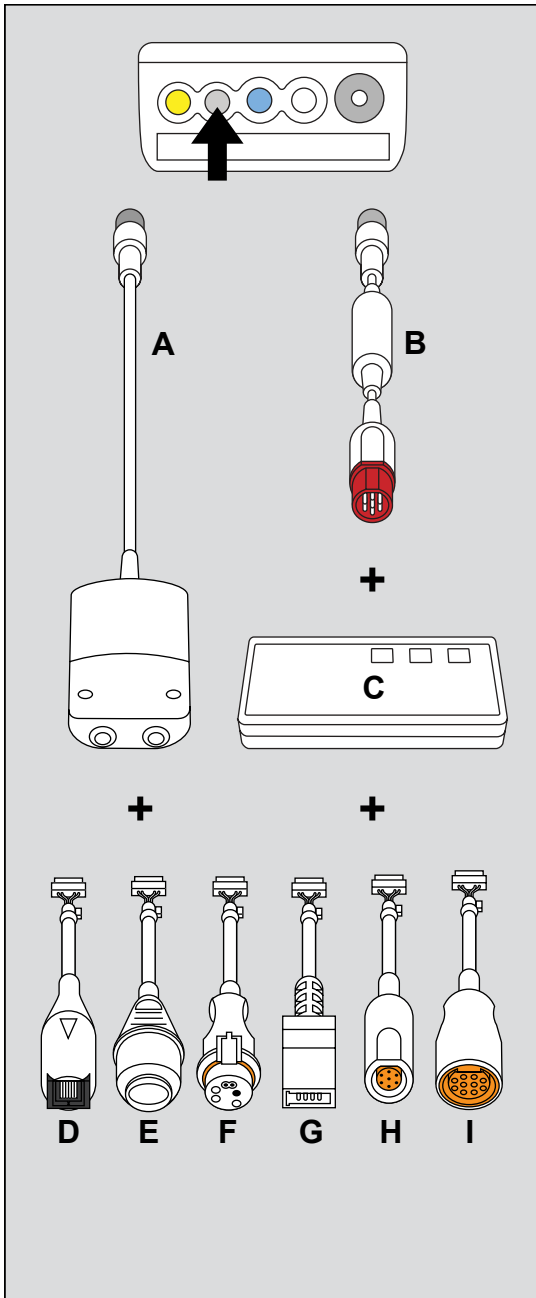

### IBP cables

	Part	Part number
<b>A</b>	MCable – Dual Hemo	MS20783
<b>B</b>	M540 - Connect cable, 1.5 m (4.9 ft) <sup>1)</sup>	MS23897
	M540 Hemo Connect cable, 2.9 m (9.5 ft) <sup>1)</sup>	MS23898
<b>C</b>	MPod – QuadHemo	MS20725

#### NOTE

<sup>1)</sup>The M540 Hemo Connect cable is used with the MPod – QuadHemo (not necessary for the MCable – Dual Hemo).

### Transducer adapter cables

	Part	Part number
<b>D</b>	Abbott-Medex (Transtar)	MS22535
<b>E</b>	Baxter-Edwards	MS22147
<b>F</b>	Becton/Dickinson	MS22148
<b>G</b>	Utah Medical	MS22534
<b>H</b>	Dräger 7-pin	MS22533
<b>I</b>	Dräger 10-pin	MS22532

## Non-invasive blood pressure (NIBP) monitoring – Dräger connectors

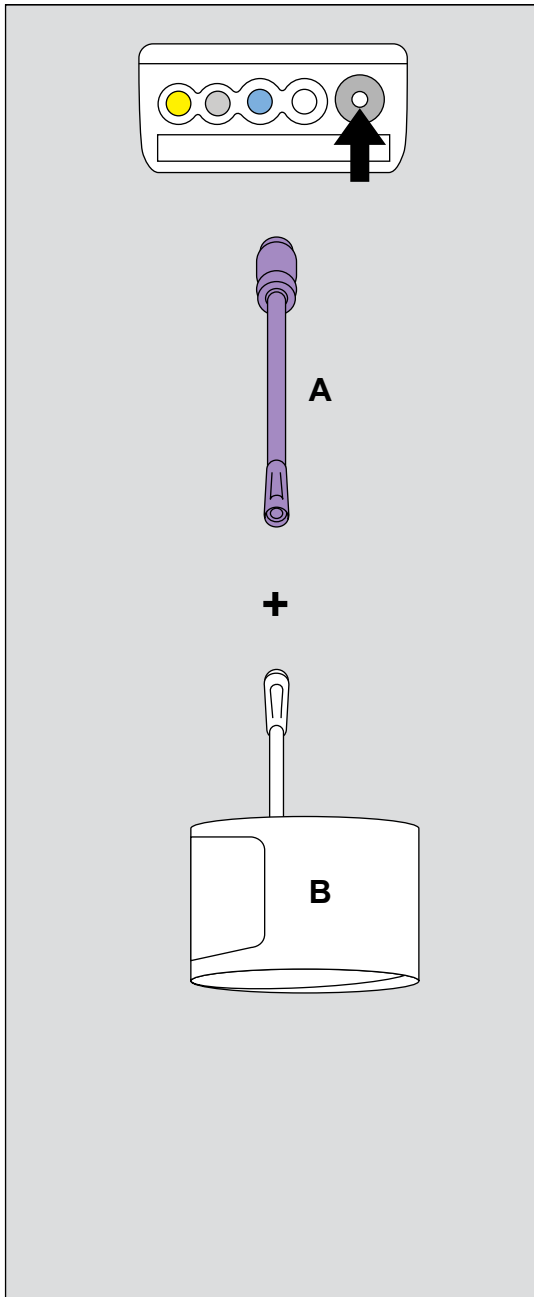

### NIBP hose

The following single-patient use and reusable cuffs and hose use Dräger connectors.

	Part	Part number
<b>A</b>	Connection tube, adult/pediatric 3.7 m (12.15 ft)	MP00953

### Reusable adult/pediatric NIBP cuffs

#### NOTE

All cuffs are latex-free.

	Part	Part number
<b>B</b>	Infant arm cuff, XXS 8 to 13 cm (3 to 5 in)	MP00911
	Child arm cuff, XS 12 to 19 cm (5 to 7 in)	MP00912
	Small adult arm cuff, S 17 to 29 cm (6 to 10 in)	MP00913
	Adult arm cuff, M 23 to 33 cm (9 to 13 in)	MP00915
	Adult arm cuff, M+ 23 to 43 cm (9 to 17 in)	MP00916
	Adult arm cuff, M++ 23 to 53 cm (9 to 21 in)	MP00917
	Large adult arm cuff, L 31 to 40 cm (12 to 16 in)	MP00918
	Large adult arm cuff, L+ 31 to 55 cm (12 to 22 in)	MP00919
	Large adult thigh cuff, XL 38 to 50 cm (15 to 20 in)	MP00921

## Single-patient use adult/pediatric NIBP cuffs

See the illustration on page 21.

	<b>Part</b>	<b>Part number</b>
<b>B</b>	Infant arm cuff, XXS, 8 to 13 cm (3 to 5 in) 10 pieces	MP00924
	Child arm cuff, XS, 12 to 19 cm (5 to 7 in) 10 pieces	MP00925
	Small adult arm cuff, S, 17 to 29 cm (6 to 11 in) 10 pieces	MP00926
	Adult arm cuff, M, 23 to 33 cm (9 to 13 in) 10 pieces	MP00928
	Adult arm cuff, M+, 23 to 43 cm (9 to 17 in) 10 pieces	MP00929
	Adult arm cuff, M++, 23 to 53 cm (9 to 21 in) 10 pieces	MP00930
	Adult arm cuff, L, 31 to 40 cm (12 to 16 in) 10 pieces	MP00931
	Adult arm cuff, L+, 31 to 55 cm (12 to 22 in) 10 pieces	MP00932
	Adult thigh cuff, XL, 38 to 50 cm (15 to 20 in) 10 pieces	MP00934

## Non-invasive blood pressure (NIBP) monitoring – neonatal

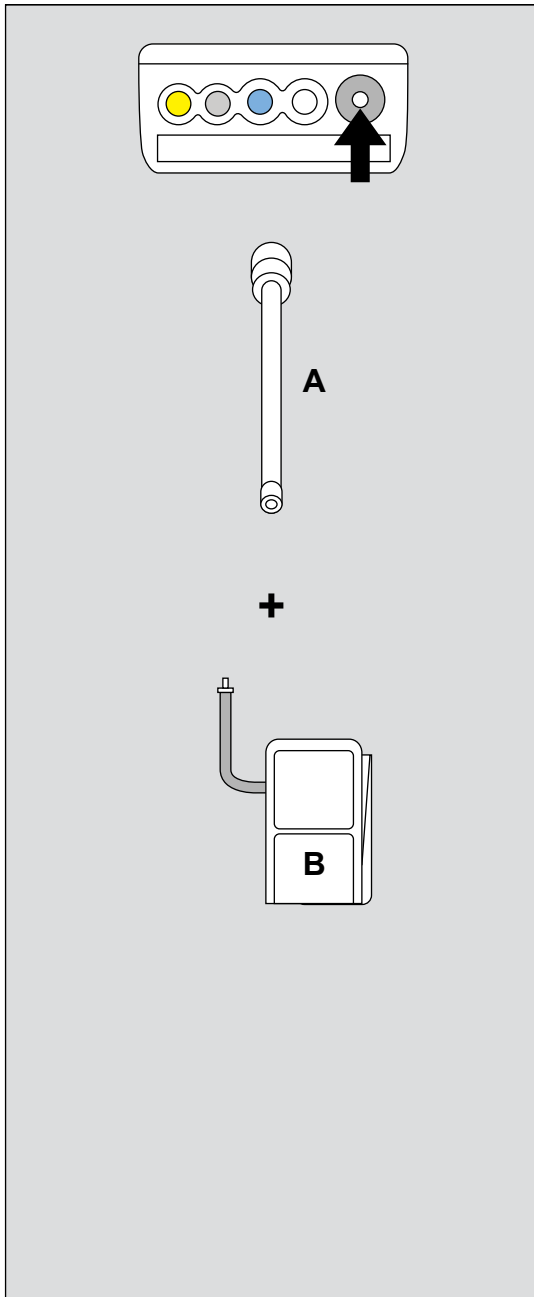

### NIBP hose

The following single-patient use and reusable cuffs and hoses use universal connectors.

	Part	Part number
<b>A</b>	Neonatal NIBP hose, 2.4 m (7.87 ft)	2870298

### Single-patient use neonatal NIBP cuffs

	Part (arm circumference)	Part number
<b>B</b>	Neonatal cuff #1 3.1 to 5.7 cm (1.2 to 2.2 in)	2870181
	Neonatal cuff #2 4.3 to 8.0 cm (1.7 to 3.1 in)	2870199
	Neonatal cuff #3 5.8 to 10.9 cm (2.3 to 4.3 in)	2870207
	Neonatal cuff #4 7.1 to 13.1 cm (2.8 to 5.1 in)	2870215
	Neonatal cuff #5 8.3 to 15.0 cm (3.2 to 6 in)	2870173

## Pulse oximetry (SpO<sub>2</sub>) monitoring – Masimo Rainbow SET (LNCS)

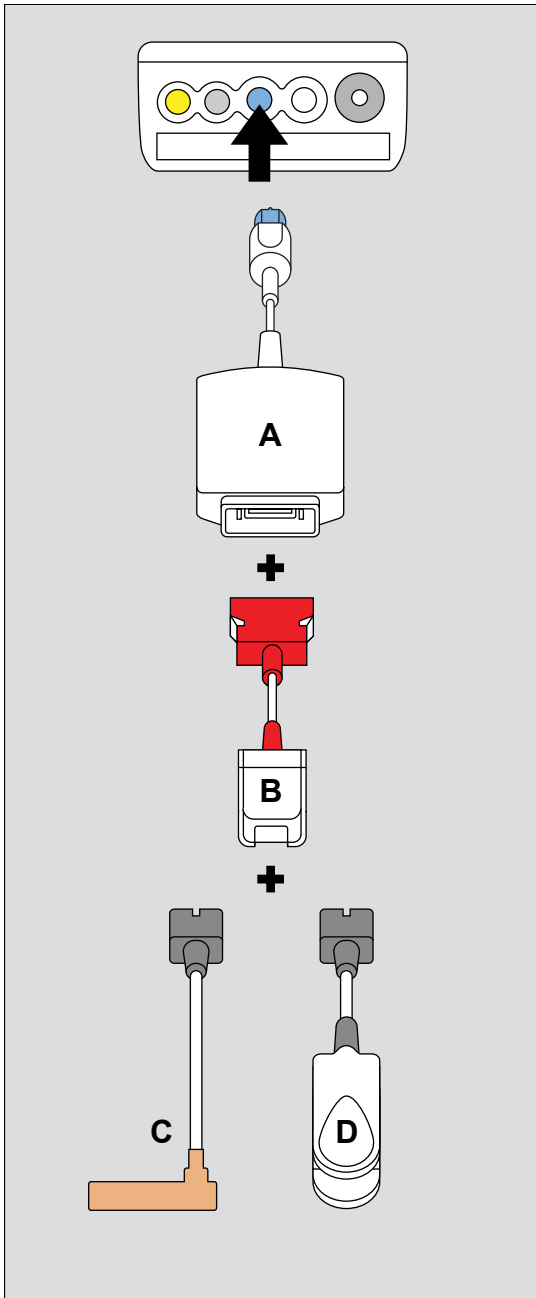

### Masimo SpO<sub>2</sub> cables

	Part	Part number
<b>A</b>	Infinity MCable - Masimo Rainbow SET	MS27003
<b>B</b>	Red LNC-10 intermediate cable, LNCS 3 m (10 ft)	MP02992

The following tables list the compatible sensors available for purchase from Dräger.

### Masimo single-patient use LNCS sensors

	Part	Part number
<b>C</b>	Adtx, adult, 20 pieces	MP00790
	Inf/Inf-3, infant, 20 pieces	MP00791
	Neo/Neo-3, neonatal, 20 pieces	MP00792
	NeoPt/NeoPt-3, preterm, 20 pieces	MP00794
	Pdtx, pediatric, 20 pieces	MP00793

### Masimo reusable LNCS sensors

	Part	Part number
<b>D</b>	DCI adult digit	MP00796
	DCIP pediatric digit	MP00795

### Not shown

	TC-I adult ear	MP00788
	YI adult/pediatric/infant/neonatal multi-site	MP00789
	TF-I adult forehead	MP00799



**Masimo SpO<sub>2</sub> accessories (not shown)**

<b>Part</b>	<b>Part number</b>
Adhesive SpO <sub>2</sub> square, 12 pieces	7496875
Clothing clip, 5 pieces	7496883
Petite wrap-adult/pedi/neo	7496909
Posey wrap, 12 pieces	7496933
Sensor tape replacement, 100 pieces	7496925

**Pulse oximetry (SpO<sub>2</sub>) monitoring – Masimo Rainbow SET**

---

For information regarding the compatibility of Masimo cables and sensors, contact your local Dräger representative.

## Pulse oximetry (SpO<sub>2</sub>) monitoring – Nellcor OxiMax

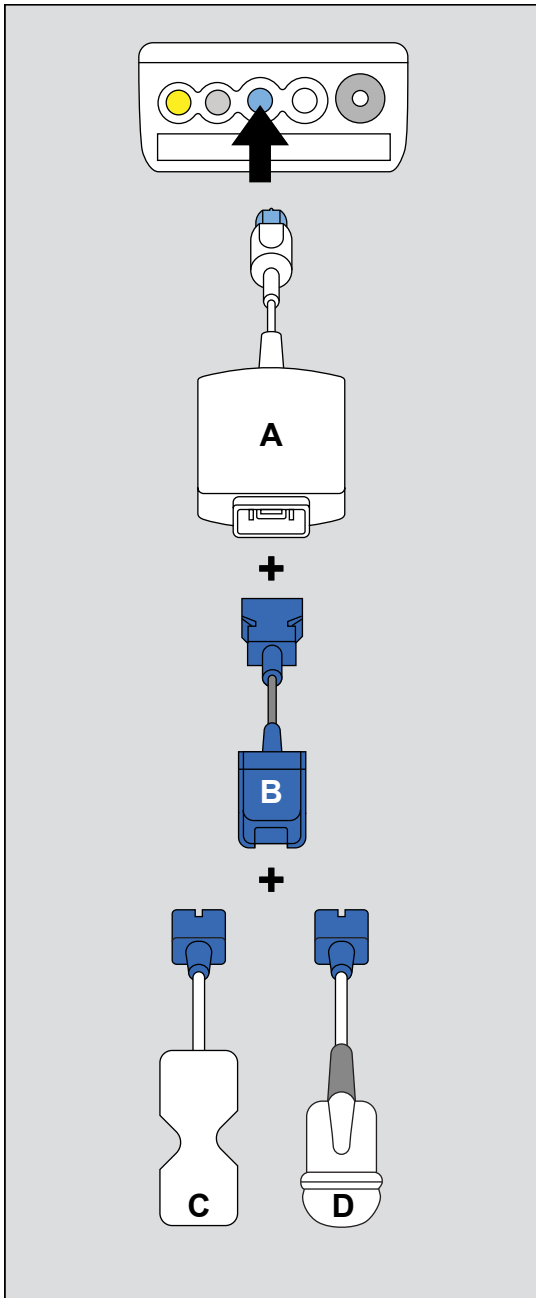

### Nellcor SpO<sub>2</sub> cables

	Part	Part number
<b>A</b>	Infinity MCable - Nellcor OxiMax	MS20668
<b>B</b>	Nellcor intermediate cable, 1.2 m (3.9 ft)	MP00748
	Nellcor intermediate cable, 3 m (9.8 ft)	MS20979

### Nellcor single-patient use sensors

The following tables list the compatible sensors available for purchase from Dräger.

	Part	Part number
<b>C</b>	OxiMax MaxA, 46 cm (18 in) cable, 24 pieces	MX50065
	OxiMax MaxAL, 91 cm (36 in) cable, 24 pieces	MX50071
	OxiMax MaxI, infant, 24 pieces	MX50067
	OxiMax MaxN, neo/adult, 24 pieces	MX50068
	OxiMax MaxP, pediatric, 24 pieces	MX50066
	OxiBand Oxi-P/I, ped/inf, 100 pieces	2170221

### Nellcor reusable sensor

	Part	Part number
<b>D</b>	Durasensor DS100A, adult, finger	7262764

## Cardiac output monitoring

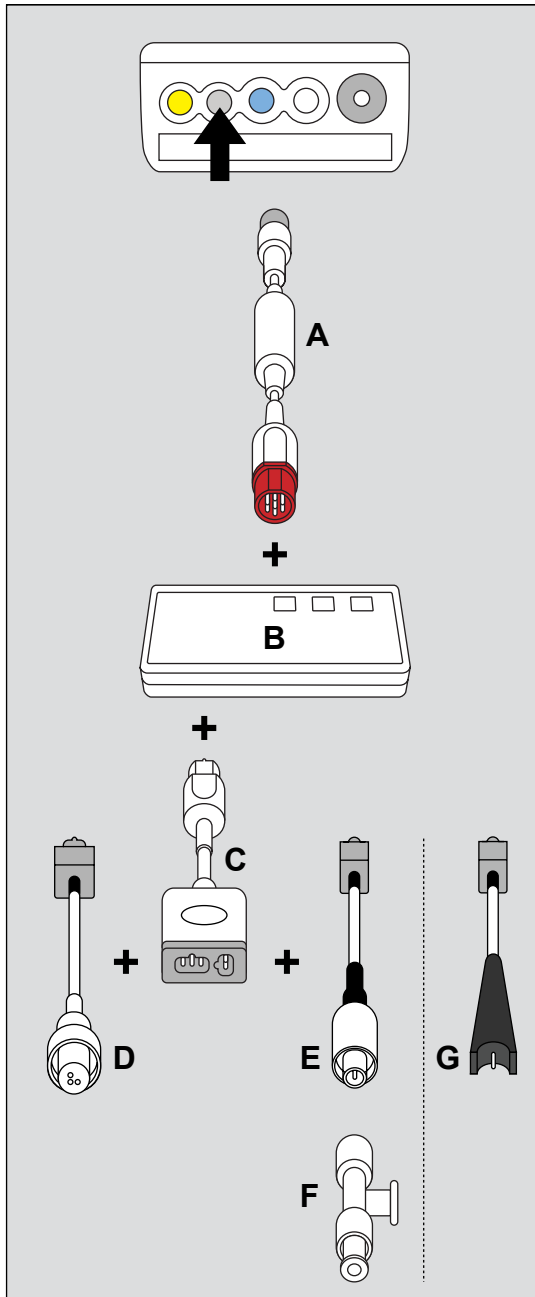

### C.O. cables, catheters, and thermistors

	Part	Part number
A	M540 Hemo connection cable, 1.5 m (4.9 ft)	MS23897
	M540 Hemo connection cable, 2.9 m (9.5 ft)	MS23898
B	MPod – QuadHemo	MS20725
	Hemo2 pod ( <i>not shown</i> )	4319435
	Hemo4 pod ( <i>not shown</i> )	4315961
C	Intermediate cable, 1 m (3.3 ft)	3368458
D	Catheter to intermediate cable	8419160
E	Thermistor cable, Ohmeda	8420077
F	Thermistor T-piece, 25 pieces	5741975
G	Thermistor cable, Baxter-Edwards	8539983

### Cardiac output kits (not shown)

	Part	Part number
	Cardiac output kit, Baxter <sup>1)</sup>	7265155
	Cardiac output kit, Ohmeda <sup>1)</sup>	7265163
<b>NOTE</b>		
<sup>1)</sup> Kit includes intermediate cable, catheter cable, and thermistor cable.		

## CO2 monitoring

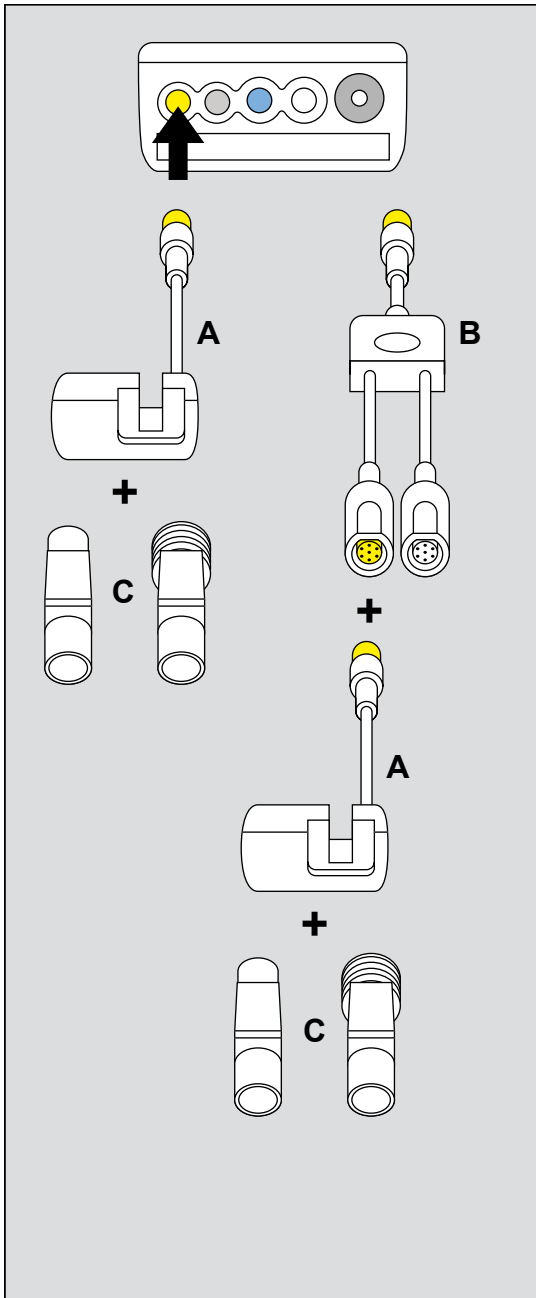

### CO2 cables

	Part	Part number
<b>A</b>	MCable - Mainstream CO2	6871950
<b>B</b>	Y-cable CO2 and analog/sync <sup>1)</sup>	MS22259

#### NOTE

<sup>1)</sup> The Y-cable allows simultaneous use of the MCable - Mainstream CO2 and MCable - Analog/Sync.

### Disposable airway adapters

	Part	Part number
<b>C</b>	Airway adapter main, adult	MP01062
	Airway adapter main, pediatric	MP01063

### Reusable airway adapters

	Part	Part number
<b>C</b>	Airway adapter main, adult	6870279
	Airway adapter main, pediatric	6870280

### Additional accessories (not shown)

Part	Part number
Calibration set	8412710
CO2 Test gas cylinder	6850435
Parking holder for CO2 sensor	8416352
Test filter	6870281

073

## Temperature monitoring

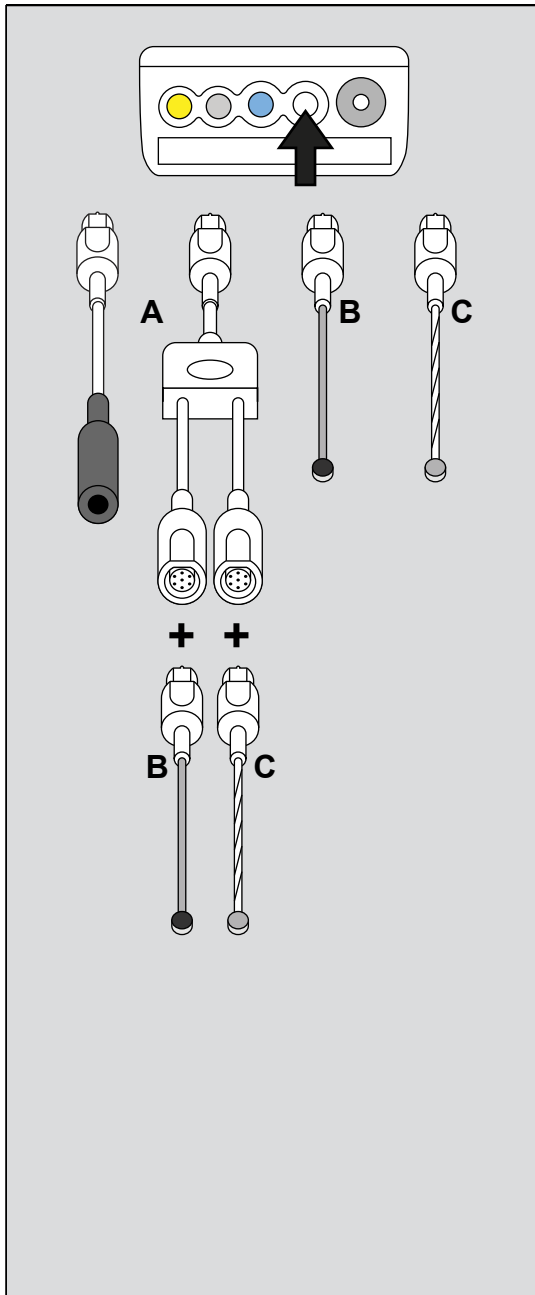

### Temperature cables

	Part	Part No
A	Adapter cable 7-pin connector for Temperature probe with 1/4" connector	5198333
	Dual temperature Y cable, 7-pin	5592154

### Skin probes

#### WARNING

Temperature skin probes are not for use in electrosurgery.

#### Adult reusable

	Part	Part number
B	Temperature skin probe, 1.5 m (4.9 ft)	4329822
	Temperature skin probe, 3 m (9.8 ft)	5204669

#### Adult single-patient use

	Part	Part number
C	Temperature skin probe, adult, 1.6 m (5.2 ft)	MP00995
	Temperature skin probe, adult, 3 m (9.8 ft)	MP00996

#### Pediatric/neonatal single-patient use

	Part	Part number
C	Temperature skin probe, pediatric, 1.6 m (5.2 ft)	MP00997
	Temperature skin probe, pediatric, 3 m (9.8 ft)	MP00998

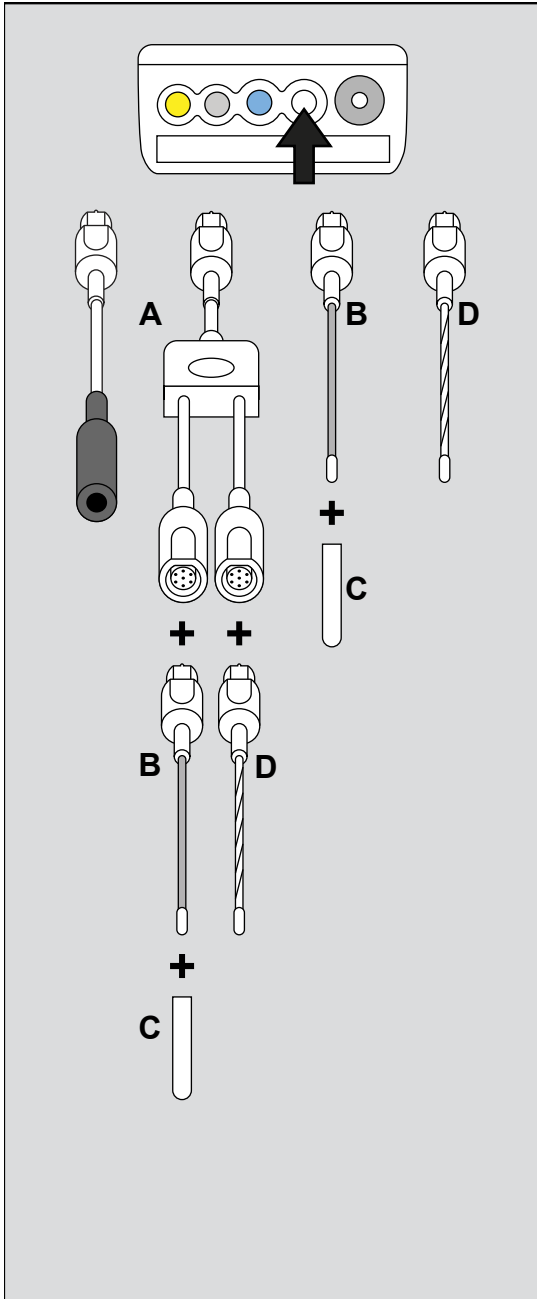

### Temperature cables

	Part	Part No
A	Adapter cable 7-pin connector for Temperature probe with 1/4" connector	5198333
	Dual temperature Y cable, 7-pin	5592154

### General purpose probes

#### WARNING

Temperature probe covers contain latex.

#### NOTE

Cover internally placed reusable temperature sensors with temperature probe sheaths.

#### Adult reusable general purpose probes

	Part	Part number
B	Temperature probe, adult 1.5 m (4.9 ft)	4329889
	Temperature probe, adult 3 m (9.8 ft)	5204644
C	Core probe covers, 20 cm, 10 pieces (contains latex)	7014616

#### Pediatric reusable general purpose probes

	Part	Part number
B	Temperature probe, pediatric, 1.5 m (4.9 ft)	4329848
	Temperature probe, pediatric, 3 m (9.8 ft)	5204651

**Adult single-patient use general purpose probes**

<b>D</b>	Temperature probe, adult, 1.6 m (5.2 ft)	MP00991
	Temperature probe, adult, 3 m (9.8 ft)	MP00992

**Pediatric single-patient use general purpose probes**

<b>D</b>	Temperature probe, pediatric, 1.6 m (5.2 ft)	MP00993
	Temperature probe, pediatric, 3 m (9.8 ft)	MP00994

**NOTE**

<sup>1)</sup> Temperature core probes can be used during electrosurgery and in esophageal and rectal applications.

**NOTE**

Temperature probes with 7-pin connectors are compatible with Hemo4 pod, Hemo2 pod, MPod – QuadHemo (see page 19).

## MCable - Analog/Sync

### Analog/sync cables

	Part	Part number
<b>A</b>	Y-cable CO <sub>2</sub> and analog/sync <sup>1)</sup>	MS22259
<b>B</b>	MCable - Analog/Sync	MS20662
<b>C</b>	Analog output cable, 5 m (16.4 ft)	4314618
	QRS sync output cable, 3 m (9.8 ft)	4314667

#### NOTE

<sup>1)</sup> The Y-cable allows simultaneous use of the MCable - Mainstream CO<sub>2</sub> and MCable - Analog/Sync.

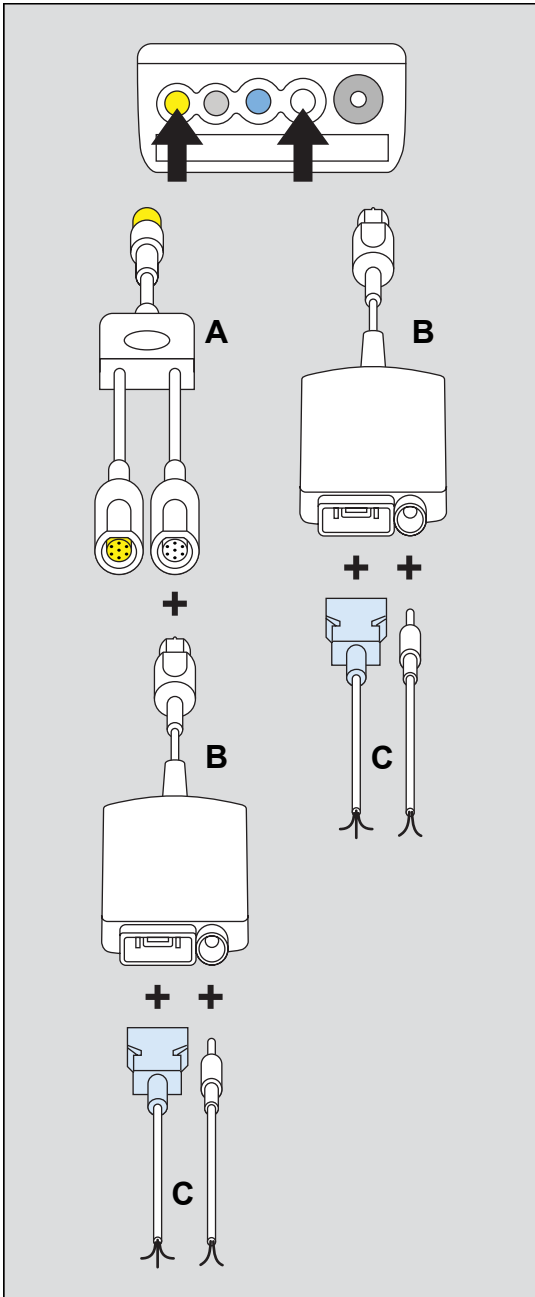

071



This page intentionally left blank

These Instructions for Use only apply to  
**Infinity Acute Care System - Monitoring  
Applications SW VG2**

with the Serial No.:

If no Serial No. has been filled in by Dräger,  
these Instructions for Use are provided for gen-  
eral information only and are not intended for  
use with any specific machine or unit.

This document is provided for customer informa-  
tion only, and will not be updated or exchanged  
without customer request.



Directive 93/42/ECC  
concerning medical products

 **Manufacturer**  
**Dräger Medical GmbH**  
 Moislinger Allee 53 – 55  
D-23542 Lübeck  
 Germany  
+49 451 8 82-0  
**FAX** +49 451 8 82-20 80  
 <http://www.draeger.com>

Distributed in USA by  
**Draeger Medical, Inc.**  
 3135 Quarry Road  
Telford, PA 18969-1042  
U.S.A.  
 (215) 721-5400  
(800) 4DRAGER  
(800 437-2437)  
**FAX** (215) 723-5935  
 <http://www.draeger.com>

MS28310 – RI00– enROW

© Dräger Medical GmbH

Edition: 1 – 2011-06

Dräger reserves the right to make modifications  
to the equipment without prior notice

