

1 Safety-related information

- Before using this product, carefully read these instructions for use and those of the associated products.
- Strictly follow the instructions for use. The user must fully understand and strictly observe the instructions. Use the product only for the purposes specified in the intended use section (see section 3.2).
- Do not dispose of the instructions for use. Ensure that they are retained and appropriately used by the product user.
- Only trained and competent users are permitted to use this product.
- Comply with all local and national rules and regulations associated with this product.
- Only specialist, trained personnel are permitted to check, repair and maintain the product as described in these instructions for use and the technical manual. Further maintenance work that is not detailed in these instructions for use or in the technical manual must only be carried out by Dräger or qualified personnel. Dräger recommend a Dräger service contract for all maintenance activities.
- Only use genuine Dräger spare parts and accessories when performing maintenance work, or the proper functioning of the product may be impaired.
- Do not use a faulty or incomplete product. Do not modify the product.
- Notify Dräger in the event of any component fault or failure.

2 Conventions in this document

2.1 Definitions of alert icons

The following alert icons are used in this document to provide and highlight areas of the associated text that require a greater awareness by the user. A definition of the meaning of each icon is as follows:

WARNING

Indicates a potentially hazardous situation which, if not avoided, could result in death or serious injury.

CAUTION

Indicates a potentially hazardous situation which, if not avoided, could result in physical injury. It may also be used to alert against unsafe practices.

NOTICE

Indicates a situation which, if not avoided, could result in damage to the product or the environment.

2.2 Typographical conventions

▶ A triangle is used in safety statements to indicate possible ways of avoiding the hazard.

 An information symbol is used for notes and additional useful information.

1. Numbered paragraphs indicate that the information is sequential.
- Dashed paragraphs indicate that the information is non-sequential.

2.3 Trademarks

The following website lists the countries in which the Dräger trademarks are registered: www.draeger.com/trademarks.

Molykote® is a registered trademark of DDP Specialty Electronic Materials US 9, LLC.

The trademarks listed are only registered in certain countries and not necessarily in the country in which this document is published.

3 Description

3.1 Feature description

The PSS® AirBoss Active is a breathing apparatus that provides the wearer with respiratory protection using an open-circuit, pressure-demand, compressed-air system. The product is compatible with Dräger compressed air cylinders, masks and lung demand valves.

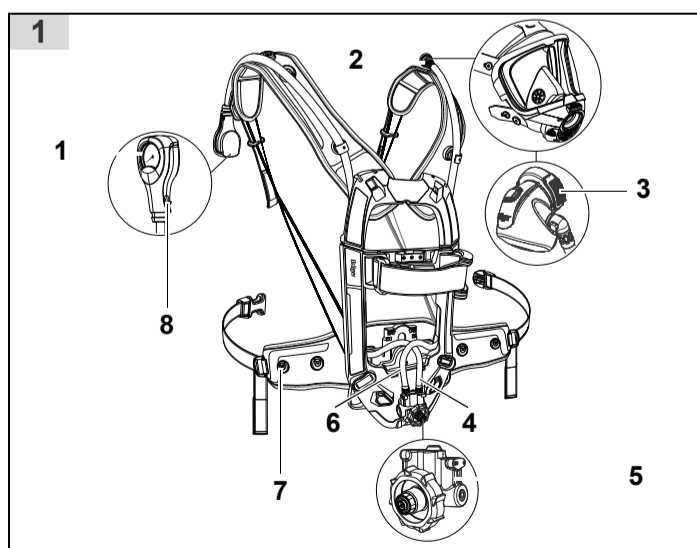

3.1.1 Carrying system

The carrying system has a carbon-composite backplate, with adjustable shoulder straps and waist belt connected using quick release connectors. Some variants feature an adjustable backplate where the height can be changed to one of three preset heights to suit the body length of the wearer (short (S), medium (M) and long (L)). The waist pad is connected at a flexible joint to compensate for the twisting and bending of the user. Pneumatic hoses and other modular components are integrated into the backplate to prevent snagging and to enhance component protection. Universal accessory clips (Fig 1, Item 7) can be fitted to the shoulder and waist pads.

3.1.2 Pneumatic system

The breathing apparatus uses a Dräger high-performance pressure reducer (Fig 1, Item 5) that reduces cylinder pressure. Breathing air is supplied through a medium-pressure hose (6) and coupling (2) to the attached lung demand valve (3). A pressure relief valve will activate and vent air to the atmosphere at the pressure reducer (Fig 2) if the medium-pressure increases to 11–16 bar. High-pressure air is supplied through an internal capillary inside the dual-pressure hose (Fig 1, Item 4) to the gauge (1). Air is also supplied through the dual-pressure hose to the warning whistle (8) when the pneumatic pressure is low.

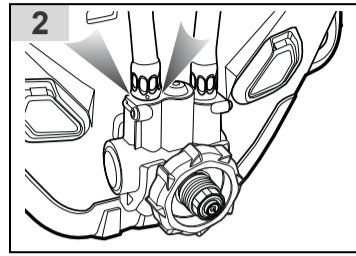

3.1.3 Compressed air cylinders

The breathing apparatus is compatible with steel or composite material cylinders of 4 to 9 litre capacities, and 200 or 300 bar pressure. Full descriptions and user instructions are contained in separate instructions supplied with the cylinder.

3.1.4 Face masks

The breathing apparatus is compatible with FPS® 7000 and Panorama® Nova face masks. Full descriptions and user instructions are contained in separate instructions supplied with the face mask.

3.1.5 Lung demand valves

The breathing apparatus is compatible with PSS® lung demand valves with the following types of connector: A, AE, ESA, and N. Full descriptions and user instructions are contained in separate instructions supplied with the lung demand valve.

3.2 Intended use

When the product is used with an approved compressed air cylinder, mask and lung demand valve, the breathing apparatus provides a wearer with respiratory protection for working in contaminated or oxygen-deficient conditions.

The compressed air cylinder, mask, lung demand valve, and other accessories used with this product must be certified Dräger components. They must be assembled in an approved configuration and used as described in this document and in separate instructions supplied with the accessories, otherwise operation of the product may be impaired.

3.3 Use in explosive atmospheres

The PSS AirBoss Agile, as defined in the feature description (section 3.1), is type tested for use in potentially explosive atmospheres and is suitable for use in hazardous areas up to and including zone 0 and zone 20. For further information please contact Dräger.

3.4 Approvals

The European standards, guidelines, and directives according to which this product is approved are specified in the declaration of conformity (see the declaration of conformity or www.draeger.com/product-certificates).

3.5 Product marking and symbols

3.5.1 Product marking

 Do not remove or alter any product label or marking.

Labels (Fig 3) on the product provide the following information:

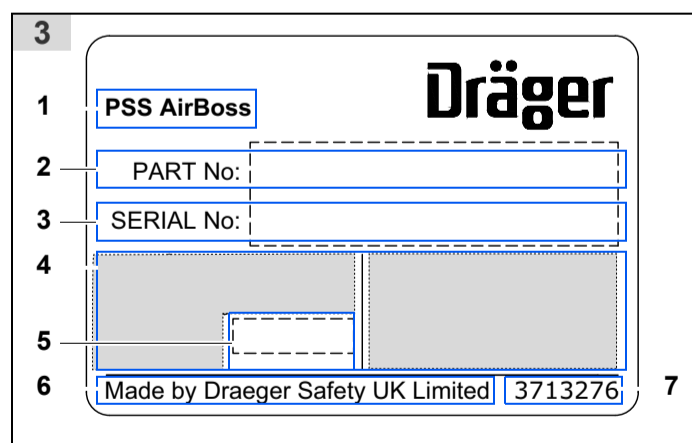

No	Description
1	Product name
2	Dräger part number
3	Dräger serial number
4	Approval information (see section 3.4)
5	Year of manufacture
6	Manufacturer
7	Label part number

The following symbols can also be found on the product.

Symbol	Description
	Radio-frequency identification symbol

Refer to the relevant authority for explanation of approval body symbols and marking on the product.

4 Use

WARNING

Only trained and competent users (those who have attended a relevant training course) are permitted to prepare and use this product.

- ▶ Ensure that any accessories, ancillary equipment, and other protective clothing items do not interfere with the breathing apparatus and do not create a safety hazard.

WARNING

The effective working duration of the breathing apparatus depends on the initial air supply available and the breathing rate of the wearer.

- ▶ Fill compressed air cylinders to their full rated pressure before use.
- ▶ Do not commence any operation using a cylinder that is less than 90 percent full.

CAUTION

Equipment damage can cause the release of high-pressure air.

- ▶ Do not apply excessive force or use tools to open or close a cylinder valve.
- ▶ Do not drop or throw down the breathing apparatus.

4.1 Preparation for use

4.1.1 Before using the breathing apparatus

1. Carry out a visual inspection of the breathing apparatus (see section 6.3.1).
2. Fit the cylinder (see section 4.4.6).
3. Adjustable backplate only: adjust the height to the position required by the wearer (see section 4.4.3).
4. Check the male element of the medium-pressure quick coupling for burring (see section 6.3.2).
5. If using a push-in type lung demand valve, check the connector for lubricant (see section 4.4.4).
6. Press the reset button (Fig 4, Item 1) to switch off the positive pressure.

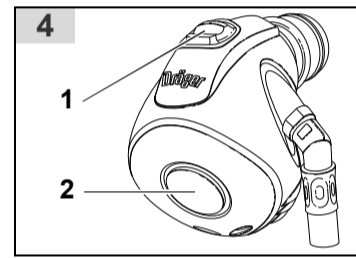

7. Carry out a full functional test of the breathing apparatus (see section 6.3.3).
8. Connect the lung demand valve to the mask (see the lung demand valve instructions for use). Check the security of attachment by gently attempting to pull the coupling apart.
9. Put on the breathing apparatus (see section 4.4.1).

4.2 During use

WARNING

Users should be in a safe area before the warning whistle begins to sound.

- ▶ Fully open all cylinder valves and ensure that they remain open during use.
- ▶ Evacuate to a safe area immediately if the warning whistle begins to sound during an operation.

- Regularly check the remaining cylinder pressure on the gauge.

WARNING

Using supplementary air may greatly reduce the operating duration of the air supply.

- ▶ When supplementary air is used, the user must immediately evacuate to a safe area.
- ▶ The reason for using supplementary air must be investigated and repaired before reusing the breathing apparatus.

If supplementary air is required, briefly press the rubber cover at the front of the lung demand valve to deliver extra air into the mask.

4.3 After use

4.3.1 After using the breathing apparatus

1. Take off the breathing apparatus (see section 4.4.2).
2. Carry out a visual inspection of the breathing apparatus (see section 6.3.1).
3. Carry out a full functional test of the breathing apparatus (see section 6.3.3).
4. If using a push-in type lung demand valve, check the connector for lubricant (see section 4.4.4).
5. Remove the cylinder if necessary (see section 4.4.6).
6. Charge the cylinder (see section 6.3.4).
7. Pass the breathing apparatus to the service department with details of any faults or damage that occurred during use.

4.4 Common tasks

4.4.1 Putting on the breathing apparatus

1. Fully loosen the shoulder straps and waist belt.
2. Put on the breathing apparatus.
3. Check that the shoulder pads are not twisted then take the weight of the breathing apparatus on the shoulders by pulling the shoulder pull-down straps. Do not fully tighten at this stage.
4. Close the waist belt buckle.

- Pull the ends of the waist belt forward until the belt padding fits securely and comfortably over the hips (Fig 5).

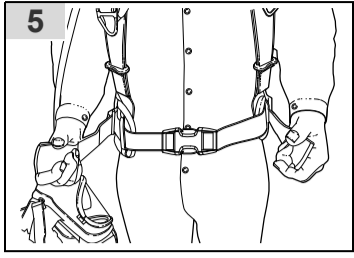

5283

- Tuck the belt straps behind the waist pad.
- Pull the shoulder pull-down straps until the breathing apparatus rests securely and comfortably on the hips. Do not over tighten.
- Pull the strap retainers down to secure the strap ends (Fig 6).

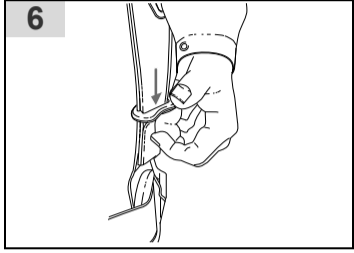

5284

- Fully loosen the mask straps.
- Place the neck strap over the back of the neck (Fig 7).

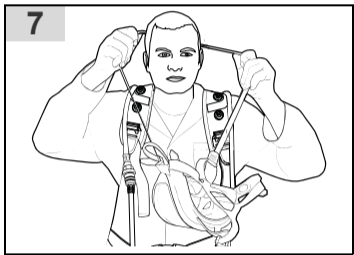

5292

- Press the reset button (Fig 4, Item 1).
- Open the cylinder valve slowly, but fully, to pressurize the system.
- Put on the mask and check the seal between the mask and the face of the wearer (see the mask instructions for use).

4.4.2 Taking off the breathing apparatus

WARNING
Removing the breathing apparatus in a hazardous breathing environment is unsafe.
▶ Do not remove the breathing apparatus until in a safe breathing environment.

NOTICE
The product can be damaged if removed incorrectly.
▶ Do not remove the mask by pulling the lung demand valve.

- Loosen the mask straps.
- At the point when the seal between the mask and face is broken, press the reset button (Fig 4, Item 1).
- Fully remove the mask and extend all the straps.
- Close the cylinder valve.
- Press the front button (Fig 4, Item 2) to vent the pneumatic system.
- Press the reset button (Fig 4, Item 1).
- Release the waist belt buckle.
- Lift the shoulder harness ends to release the strap retainers (Fig 8) and then lift the shoulder strap buckles to loosen the straps.

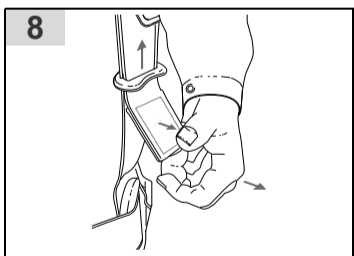

5285

- Take off the breathing apparatus.

4.4.3 Adjusting the backplate height

- Lift the apparatus into the vertical position.
- Simultaneously press the two spring-loaded buttons (Fig 9).

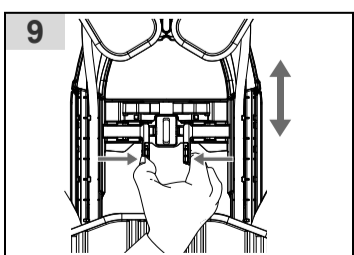

5289

- Slide the yoke in the required direction then release the buttons.
- Continue sliding the yoke until the buttons engage and lock the yoke in the required position.

4.4.4 Checking and re-lubricating the lung demand valve coupling

This task applies only to the following lung demand valve types: A and ESA.

As a guide, lubricant should be felt on the fingers but not seen. If relubrication is required, lightly apply Molykote® 111 (other lubricants are not tested and may damage the equipment).

- For type A check for lubricant on the O-ring of the lung demand valve connector.
- For type ESA check the outer surface of the male part of the push-in connector on the lung demand valve.

4.4.5 Fitting and removing accessories to universal accessory clips

4.4.5.1 Fitting an accessory to a universal accessory clip

Work equipment

- 2.5 mm hexagon key

- Remove the blanking plug from the universal accessory clip (see Fig 10).

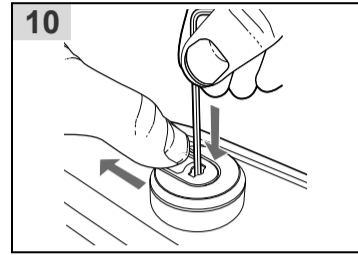

5293

- Slide the compatible accessory into the universal accessory clip (see Fig 11).

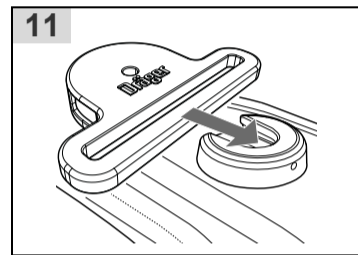

5294

- Ensure that the accessory is securely retained by the universal accessory clip.

4.4.5.2 Removing an accessory from a universal accessory clip

Work equipment

- 2.5 mm hexagon key

- Remove the accessory from the universal accessory clip (see Fig 12).

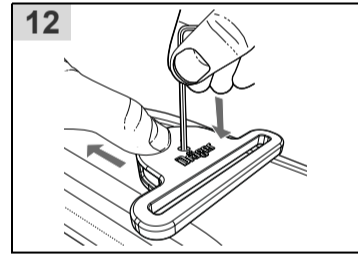

5295

- Slide a blanking plug into the universal accessory clip (see Fig 13) to protect it.

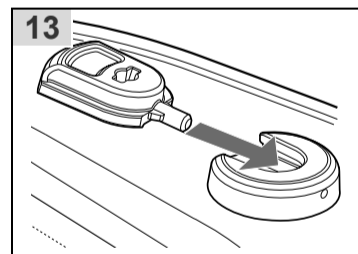

5329

- Ensure that the blanking plug is securely retained by the universal accessory clip.

4.4.6 Fitting and removing compressed air cylinders

WARNING
High-pressure air release can cause injury to the user or other personnel near the breathing apparatus.
▶ Close the cylinder valve and fully vent the system before attempting to disconnect a cylinder.

WARNING
Impact damage to the cylinder valve or pressure reducer connector can prevent valve connection or cause an air leak.
▶ Handle the cylinder and breathing apparatus with care.

For cylinder connector types not described in this document, refer to the instructions for use supplied with the connector.

4.4.6.1 Fitting a compressed air cylinder with a threaded connector

- Ensure that the cylinder is fully charged (see section 6.3.4).

- Check the threads of the cylinder valve port and the pressure reducer. Ensure that the O-ring (Fig 14, Item 1) and the sintered filter (2) in the pressure reducer are clean and undamaged.

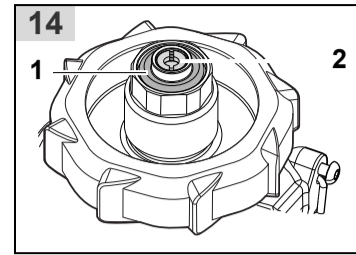

5286

- Lay the backplate horizontal, with the pressure reducer uppermost.
- Ensure that the cam lever is fully open (Fig 15, Item 1).

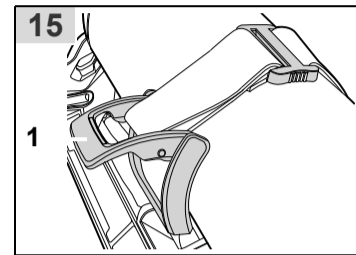

5306

- Insert the cylinder through the cylinder strap.
- Lift the cylinder and backplate into the vertical position (supported on the end of the cylinder opposite the valve).
- Align the cylinder valve with the pressure reducer (Fig 16). Tighten the hand wheel using only the thumb and index finger until a definite stop is felt. Do not use tools or over tighten.

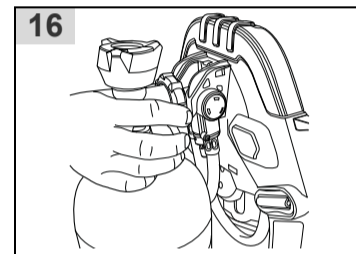

5300

- Place the backplate into the horizontal position.
- Fully close the cam lever (Fig 17).

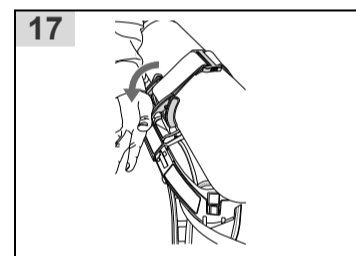

5301

- Check that the cylinder is secure. If it is not, adjust the cylinder strap (see section 4.4.6.7).

4.4.6.2 Fitting two compressed air cylinders with threaded connectors

- Ensure that the cylinders are fully charged (see section 6.3.4).
- Check the threads of the cylinder valve port and the pressure reducer. Ensure that the O-ring (Fig 18, Item 1) and the sintered filter (2) in the pressure reducer are clean and undamaged.

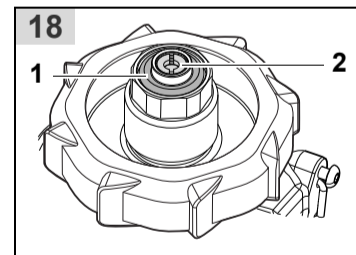

5286

- If not fitted, fit the connector piece on to the pressure reducer (Fig 19). Tighten the hand wheel using only the thumb and index finger until a definite stop is felt. Do not use tools or over tighten.

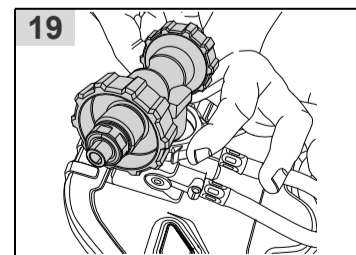

5297

- Lay the backplate horizontal, with the pressure reducer uppermost, and fully extend the cylinder strap.

5. Ensure that the cam lever is fully open (Fig 20, Item 1).

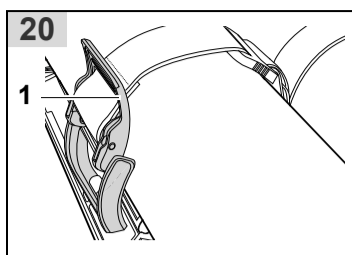

6. Form two loops in the cylinder strap with the centre strap (Fig 21).

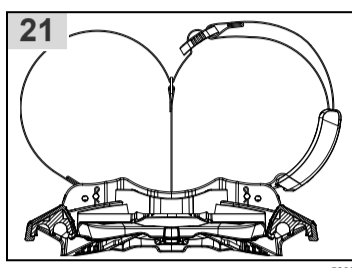

7. Insert the cylinders through the loops of the cylinder strap.
8. Align the cylinder valves with the connector piece then tighten the hand wheels using only the thumb and index finger until a definite stop is felt. Do not use tools of over tighten.
9. Fully close the cam lever (Fig 22).

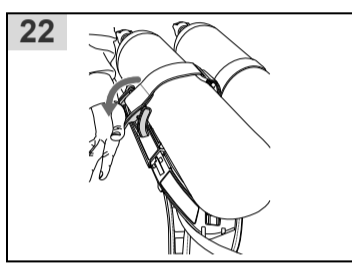

10. Check that the cylinder is secure. If it is not, adjust the cylinder strap (see section 4.4.6.8).

4.4.6.3 Removing a compressed air cylinder with a threaded connector

1. Close the cylinder valve and fully vent the system.
2. Lay the backplate horizontal, with the cylinder uppermost.
3. Fully open the cam lever (Fig 23).

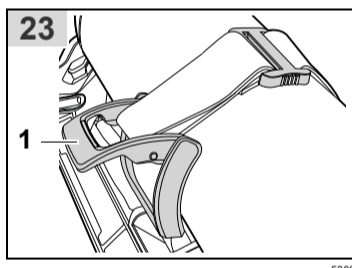

4. Disconnect the cylinder valve from the pressure reducer.
5. Lift the cylinder away from the pressure reducer and remove the cylinder.

4.4.6.4 Removing two compressed air cylinders with a threaded connector

1. Close the cylinder valve and fully vent the system.
2. Lay the backplate horizontal, with the cylinders uppermost.
3. Fully open the cam lever (Fig 24).

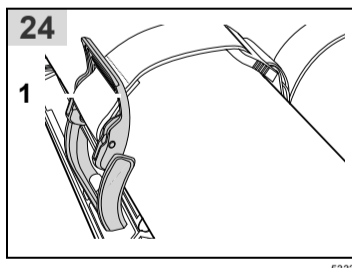

4. Disconnect the cylinder valves from the connector piece.
5. Lift the cylinders away from the connector piece and remove the cylinders.

4.4.6.5 Configuring a twin cylinder strap for use with a single cylinder

1. Pull the cylinder strap pin upwards (Fig 25).

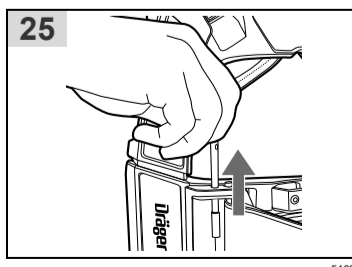

2. Move the centre strap over to the side opposite the cam lever (Fig 26).

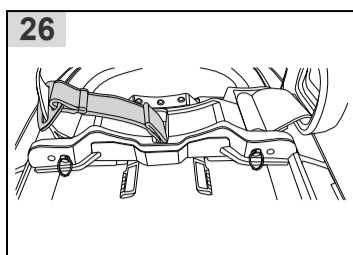

3. Make a loop from the cylinder strap between the adjuster buckle and cam-lever, and fit it to the cylinder strap pin (Fig 27).

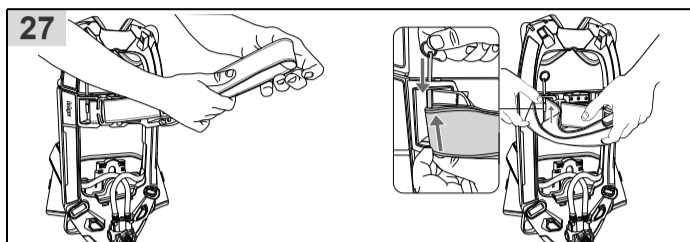

4. Push the cylinder strap pin all the way through the cylinder cradle and backplate (Fig 28).

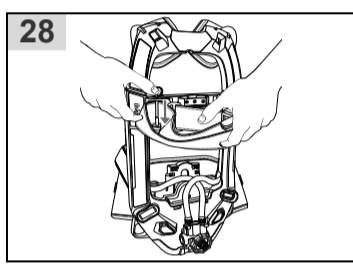

5. Fit a cylinder to the breathing apparatus (see section 4.4.6.1).
6. Adjust the cylinder strap (see section 4.4.6.7).

4.4.6.6 Configuring a twin cylinder strap for use with two cylinders

1. Pull the cylinder strap pin upwards and remove the cylinder strap from the pin (Fig 29).

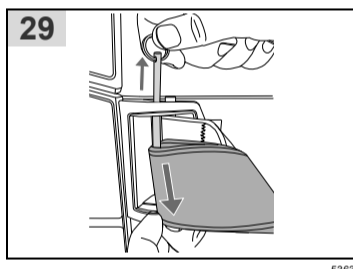

2. Push the cylinder strap pin all the way through the cylinder cradle and backplate.
3. Fit two cylinders to the breathing apparatus (see section 4.4.6.2).
4. Adjust the cylinder strap (see section 4.4.6.8).

4.4.6.7 Adjusting the single cylinder strap

1. Fit the cylinder but do not close the cam lever (see section 4.4.6.1).
2. Move the adjuster buckle (Fig 30, Item 1) so that the stitching is:
– Below the centre bar of the adjuster buckle (A, single cylinder strap).
– Above the centre bar of the adjuster buckle (B, twin cylinder strap configured for use with a single cylinder).

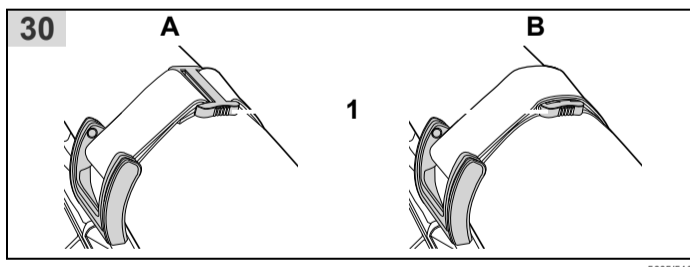

3. Close the cam lever, and check that the cylinder is secure.
4. If the cylinder is not secure, release the cam lever and move the adjuster buckle to adjust cylinder strap tension.
– Move the adjuster buckle toward the cam lever to loosen the strap.
– Move the adjuster buckle away from the cam lever to tighten the strap.
5. Continue to test and adjust until the cylinder is secure.

4.4.6.8 Adjusting the twin cylinder strap

1. Fit the cylinders but do not close the cam lever (see section 4.4.6.2).

2. Move the adjuster buckle (Fig 31, Item 1) so that the stitching is below the centre bar of the adjuster buckle.

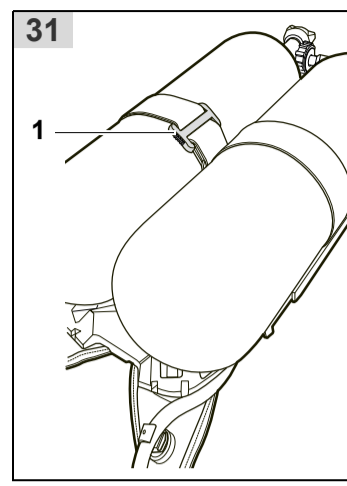

3. Close the cam lever, and check that the cylinders are secure.
4. If the cylinders are not secure, release the cam lever and move the adjuster buckle to adjust cylinder strap tension.
– Move the adjuster buckle toward the cam lever to loosen the strap.
– Move the adjuster buckle away from the cam lever to tighten the strap.
5. Continue to test and adjust until the cylinders are secure.

5 Troubleshooting

The troubleshooting guide shows fault diagnosis and repair information applicable to users of this product. Further troubleshooting and repair information is available in instructions for use supplied with associated equipment.

Where the troubleshooting guide shows more than one fault or remedy, carry out repair actions in the order that they appear in the guide.

Contact service personnel or Dräger when the remedy information indicates a service task, or if the symptom remains after all remedy actions have been attempted.

5.1 Troubleshooting for breathing apparatus

Symptom	Fault	Remedy
High-pressure air leak or failed leak test	Loose or dirty connector	Disconnect, clean and reconnect couplings and retest
	Faulty hose or component	Substitute user replaceable accessories and retest
Air leak from medium-pressure hose connector at the pressure reducer (pressure relief valve) (see Fig 2)	Faulty O-ring, retainer, spring, or pressure reducer	Service task
Air leak from lung demand valve	Ice particles on sealing elements	Allow a rush of air to pass through the valve by pressing the front button (Fig 4, Item 2) then quickly switch off the positive pressure by pressing the reset button (Fig 4, Item 1)
Air leak from cylinder connector	Ice particles on sealing elements	Close the cylinder valve and vent the system. Disconnect then reconnect the cylinder. Pressurize the system by opening the cylinder valve slowly, but fully.
Poor sounding whistle	Whistle dirty	Clean the whistle flute and retest
Whistle not functioning	Activation mechanism fault	Service task
Difficulty connecting or disconnecting the medium-pressure quick coupling	Dirty connector	Disconnect, clean and reconnect couplings, and retest
	Burring of the male coupling	Replace the hose with the male coupling

6 Maintenance

6.1 Maintenance table

Service and test the product, including out-of-use equipment, in accordance with the maintenance table. Record all service details and testing. Refer also to the instructions for use for other associated equipment.

Additional inspection and testing may be required in the country of use to ensure compliance with national regulations.

Item	Task	Every month	Every year	Every 10 years
Complete product	Visual inspection (see section 6.3.1)	X		
	Functional testing (see section 6.3.3)	X		
	Breathing cycle and static tests ¹⁾		X	
Lung demand valve	Check the male element of the quick coupling for burring (see section 6.3.2)		X	
Pressure reducer	Inspect the sintered filter ^{1) 2)}		X	
	Inspect the high-pressure connector O-ring ^{1) 3)}		X	
	Overhaul. Contact Dräger for the Repair Exchange (REX) service ⁴⁾			X
Cylinder	Check test date of cylinder	X		
	Recertification			According to national regulations in the country of use

1. These maintenance tasks can only be carried out by Dräger or trained service personnel. Details of the tests are contained in the technical manual which is issued to service personnel that have attended a relevant Dräger maintenance course.
2. Replace the sintered filter if a drop in pressure reducer performance is observed during a flow check or if it is visibly damaged.
3. Replace the high-pressure connector O-ring if it is found to leak during functional testing or if it is visibly damaged.
4. Where the breathing apparatus is subjected to a high level of use (in training establishments etc.), reduce the overhaul period for the pressure reducer. In these circumstances, Dräger recommend that the overhaul frequency should be less than 5 000 applications of use. An application of use is defined as a single use of the fully assembled breathing apparatus, where the user breathes from the air cylinder. It does not include system pressurization for pre-operational checks.

6.2 Cleaning and disinfecting

CAUTION

Trapped water and ice inside the pneumatic system can impair the operation of the product.

- ▶ Prevent any liquid from entering the pneumatic system, and thoroughly dry the product after cleaning and disinfecting.

NOTICE

Using cleaning and disinfecting methods not described in this section can damage the equipment.

- ▶ Do not exceed 60 °C for drying, and remove components from the drying facility immediately when dry. Drying time in a heated dryer must not exceed 30 minutes.
- ▶ Do not immerse pneumatic or electronic components in cleaning and disinfecting solutions or water.



For information about suitable cleaning and disinfecting agents and their specifications refer to document 9100081 at www.draeger.com/IFU.

6.2.1 Cleaning and disinfecting the breathing apparatus

Clean the breathing apparatus if it is dirty. If the equipment has been exposed to contaminants, disinfect any components that come into direct and prolonged contact with the skin.

Refer also to the instructions for use for the lung demand valve, mask, and other associated equipment.

Work equipment

- Use only clean lint-free cloths

1. Clean the breathing apparatus manually using a cloth moistened with cleaning solution to remove excess dirt.
2. Apply disinfecting solution to all internal and external surfaces.
3. Rinse all components thoroughly with clean water to remove all cleaning and disinfecting agents.
4. Dry all components using a dry cloth, in a heated dryer, or in air.
5. Contact service personnel or Dräger if disassembly of pneumatic or electronic components is required.

6.3 Maintenance tasks

6.3.1 Visual inspection

A visual inspection must fully check the product including all component parts and accessories.

1. Check that the product is clean and undamaged, paying particular attention to pneumatic system components, connectors, and elastomeric components such as hoses.
 - Typical signs of damage that can affect the operation of the product include impact, abrasion, cutting, corrosion, and discoloration.
2. Report damage to service personnel or Dräger, and do not use the product until faults are rectified.

6.3.2 Checking the medium-pressure quick coupling

This task applies only to breathing apparatus with a removable lung demand valve. If there is any difficulty disconnecting or connecting, see the troubleshooting information in section 5.

1. Press the male element into the female element of the coupling until an audible click is heard.
2. Disconnect the male element from the female element of the quick coupling.
3. Reconnect the quick coupling as per step 1.

6.3.3 Functional testing

WARNING

Failure of the product to meet any of the standards or parameters during functional testing, or any visible signs of damage, indicates a possible system fault.

- ▶ Do not use the product and report the fault to trained maintenance personnel or contact Dräger.

6.3.3.1 Leak test

1. Press the reset button of the lung demand valve.
2. Slowly and fully open the cylinder valve (anticlockwise).
 - During pressurization the whistle will sound briefly.
3. Fully close the cylinder valve.
4. After one minute, check the contents gauge and then reopen the cylinder valve.
 - The gauge must not show an increase in pressure of more than 10 bar.
 - Investigate and repair a failed leak test (see section 5), and then repeat the leak test.

6.3.3.2 Whistle test

1. Fully close the cylinder valve.
2. Observe the gauge and slowly release the pressure as follows:

- a. Cover the outlet port of the valve with the palm of the hand.
 - b. To switch on the lung demand valve press the front button (Fig 4, Item 2).
 - c. Vent the system by carefully lifting the palm of the hand from the outlet port to maintain a slow pressure decrease.
3. The whistle must begin to sound in the range 60 bar to 50 bar.
 4. Continue to vent the system until fully exhausted.
 5. Press the reset button of the lung demand valve.

6.3.4 Charging a compressed air cylinder

WARNING

Air quality for compressed air cylinders must meet the requirements for breathable air according to EN 12021.

- ▶ Ensure that the air supply meets the EN 12021 requirements.

Refer to the instructions for use supplied with the cylinder and the charging apparatus for details of charging a compressed air cylinder.

7 Transport

Transport the product in its original packaging.

8 Storage

8.1 Storage preparation

- Extend the shoulder straps, waist belt, and the straps of the mask (see section 4.4).
- Place the mask in a protective bag (contact Dräger for supply of a suitable bag).
- Route rubber hoses in such a way that the bend radius is not too acute and the hose is not stretched, compressed, or twisted.

8.2 Storage conditions

- Store the product between -15 °C and +25 °C.
- Ensure that the environment is dry, free from dust and dirt, and does not subject the equipment to wear or damage due to abrasion.
- Do not store the equipment in direct sunlight.
- Fix the product securely to any raised mounting point to prevent it from falling.
- If storing the equipment in a vehicle, ensure that the breathing apparatus is securely retained and does not interfere with the operation of the vehicle.

9 Disposal

9.1 General

Dispose of the product in accordance with applicable rules and regulations in the country of use.

10 Manufacturer and document information

 Manufacturer
Dräger Safety UK Limited
Ullswater Close
Blyth, NE24 4RG
United Kingdom
Tel: +44 1670 352 891
Fax: +44 1670 356 266

www.draeger.com

3708110_en
© Dräger Safety UK Limited
Edition: 4 – May 2021 (Edition: 1 – September 2020)
Subject to alteration