

1 产品介绍

Dräger 声光报警器用于提供声音和灯光闪烁报警。报警灯带有 3/4 NPT 外螺纹接头，接头上装有不锈钢螺母，可匹配安装在 Dräger Polytron 系列固定式气体检测仪上，也可通过搭配使用变径安装在其他品牌的固定式气体检测仪上。

 安装及使用 Dräger 声光报警器时，请务必遵守本安装说明及与本声光报警器搭配使用的固定式气体检测仪的使用说明或其他相关说明文件。操作时请注意佩戴手套等防护用品

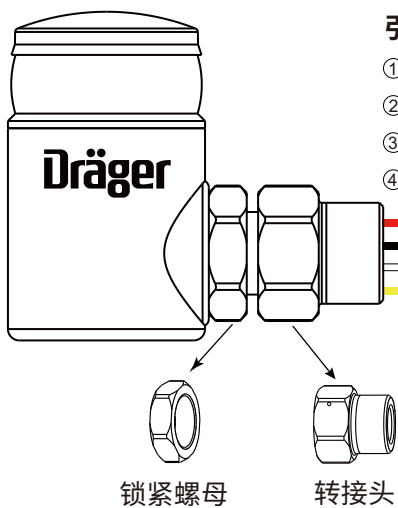

引线说明:

- ① 红线: 电源“+”
- ② 黑线: 电源“-”
- ③ 白线: A2 信号线
- ④ 黄线: A2 信号线

注:

默认情况下, ③白线和④黄线悬空, 不进行任何连接。如果将③白线和④黄线短接, 声光报警器将启用 A2 报警模式。

可选配附件(参见订货清单):

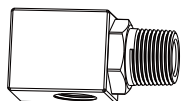

三通件

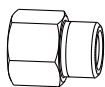

NPT延长件

| | |
|-------|--|
| 额定电压: | DC18 ~ 30V |
| 额定功率: | < 2.4W |
| 声强: | ≥ 105dB@10cm |
| 光强: | ≥ 3.4 cd@10cm |
| 光闪频率: | A1: 75 Hz A2: 120 Hz |
| 报警方式: | 声光报警 |
| 外形尺寸: | 约 87mm x 52mm |
| 外壳材质: | 304/316 不锈钢 |
| 发光颜色: | 红 / 蓝 |
| 防护等级: | IP 66/67 |
| 防爆等级: | Ex db IIC T6/T4 Gb Ex tb IIIC T80/T130 °C Db T6/T80 °C: -40 °C ≤ Ta ≤ +60 °C T4/T130 °C: -40 °C ≤ Ta ≤ +80 °C |
| 重量: | 0.6 kg |
| 接口: | NPT3/4-14 螺纹 |
| 环境湿度: | (10 ~ 95) %RH |
| 大气压力: | (86 ~ 106) kPa |
| 使用温度: | -40 °C ~ 80 °C |
| 存储温度: | -20 °C ~ 40 °C |

2 接线

Dräger Polytron 5100、5200、5310、57x0 连接声光报警器

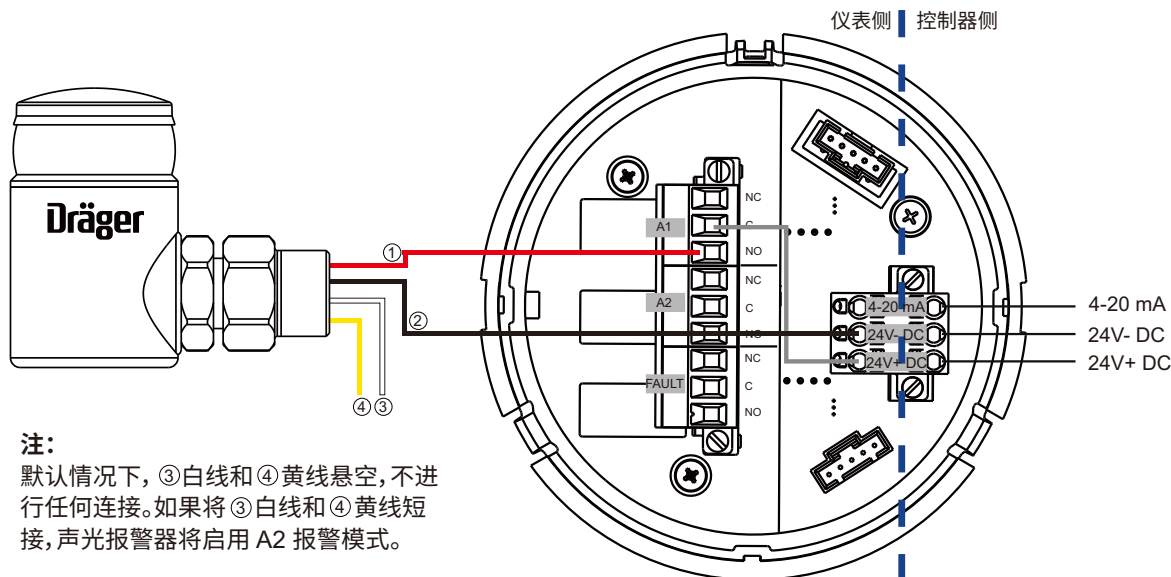

注:

默认情况下, ③白线和④黄线悬空, 不进行任何连接。如果将③白线和④黄线短接, 声光报警器将启用 A2 报警模式。

Dräger Polytron 8xx0 连接声光报警器

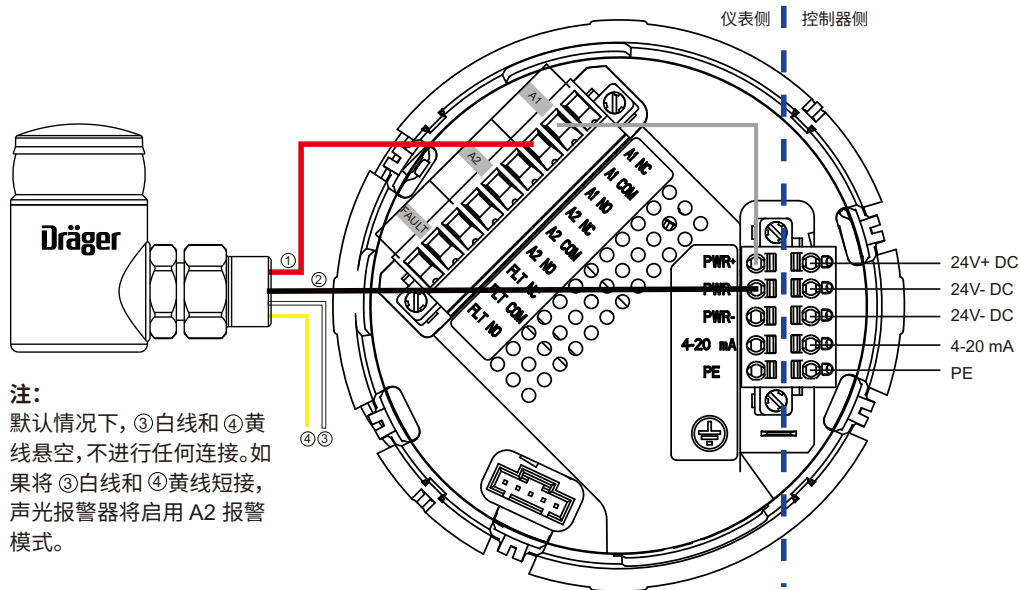

Dräger 探头数值显示器连接声光报警器

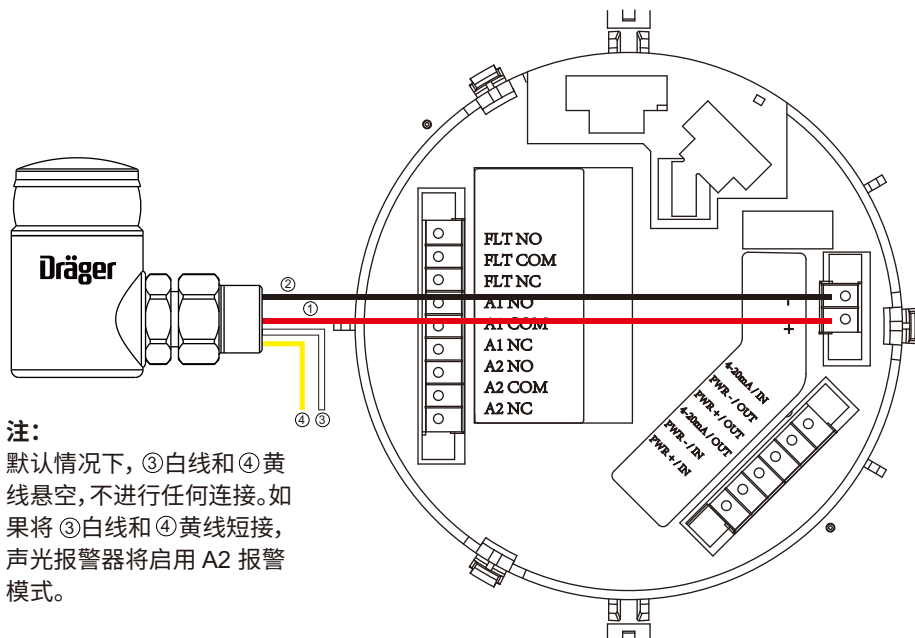

3 订货清单

| 订货号 | 说明 |
|---------|---------------------------|
| AH01363 | Dräger 声光报警器，304 不锈钢材质，红灯 |
| AH01372 | Dräger 声光报警器，304 不锈钢材质，蓝灯 |
| AH01433 | Dräger 声光报警器，316 不锈钢材质，红灯 |
| AH01434 | Dräger 声光报警器，316 不锈钢材质，蓝灯 |
| AH01025 | NPT 延长件 |
| AH01373 | 三通件 |

1 Product Introduction

Dräger Audio Lamp provides alarms with audio and flashing lamp. The product has a 3/4 NPT male connector with a stainless steel nut and is designed to be used in conjunction with Dräger Polytron series fixed gas detectors. Audio Lamp can also be installed to fixed gas detectors of other brands via an adapter.

i For installing and using Audio Lamp, please follow these wiring instructions as well as the instructions for appropriate fixed gas detector that is used with Audio Lamp, or any other relevant documents. Please wear gloves and other protective equipment during operation.

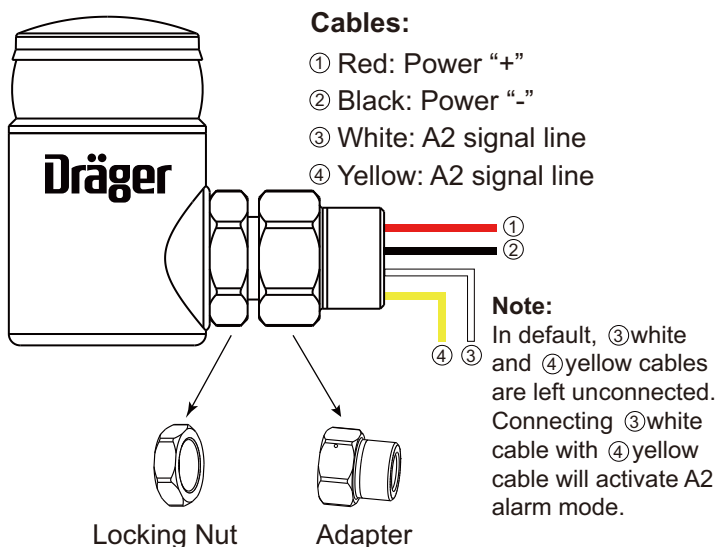

Optional accessories (see Order List)

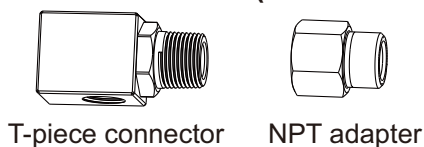

| | |
|------------------------|---|
| Rated Voltage: | DC18 ~ 30V |
| Rated Power: | < 2.4W |
| Sound Intensity: | ≥ 105dB@10cm |
| Light Intensity: | ≥ 3.4 cd@10cm |
| Flashing rate: | A1: 75 Hz A2: 120 Hz |
| Alarm Mode: | Acousto-optic Alarm |
| Dimensions: | Approx. 87mmx 52mm |
| Enclosure: | 304 / 316 Stainless Steel |
| Lamp Color: | Red / Blue |
| IP Rating: | IP 66/67 |
| Ex-protection: | Ex db IIC T6/T4 Gb Ex tb IIIC T80/T130 °C Db T6/T80 °C: -40 °C≤Ta≤+60°C T4/T130 °C: -40°C≤Ta≤+80°C |
| Weight: | 0.6 kg |
| Interface: | NPT3/4-14 thread |
| Ambient Humidity: | (10 ~ 95) %RH |
| Atmospheric Pressure: | (86 ~ 106) kPa |
| Operating Temperature: | -40 °C ~ 80 °C |
| Storage Temperature: | -20 °C ~ 40 °C |

2 Wiring

Dräger Polytron 5100, 5200, 5310, 57x0 connecting Audio Lamp

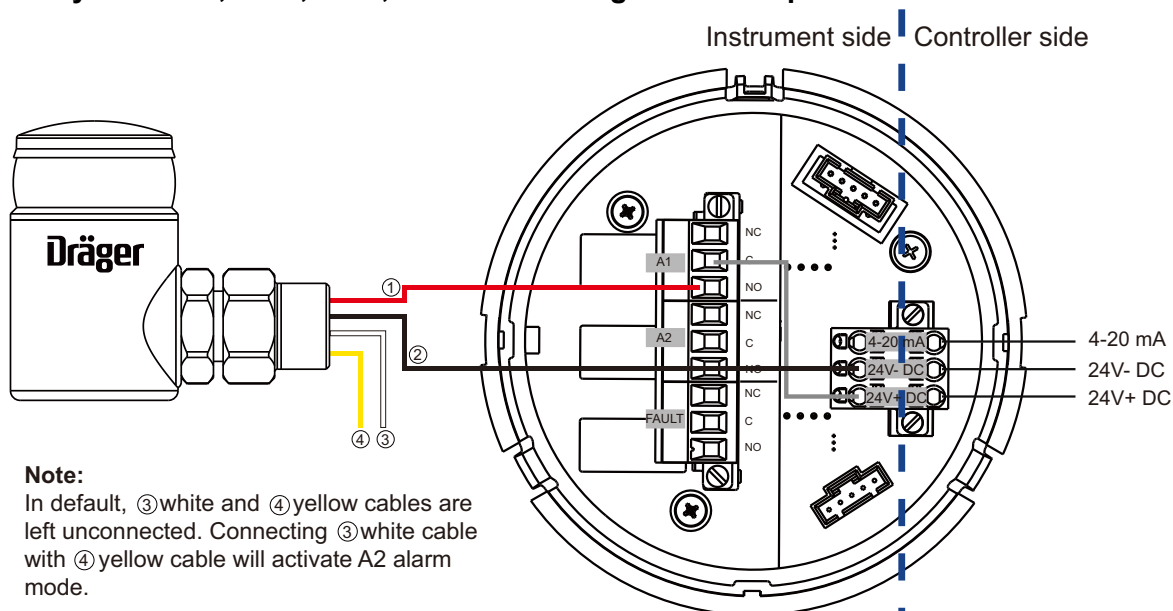

Dräger Polytron 8xx0 connecting Audio Lamp

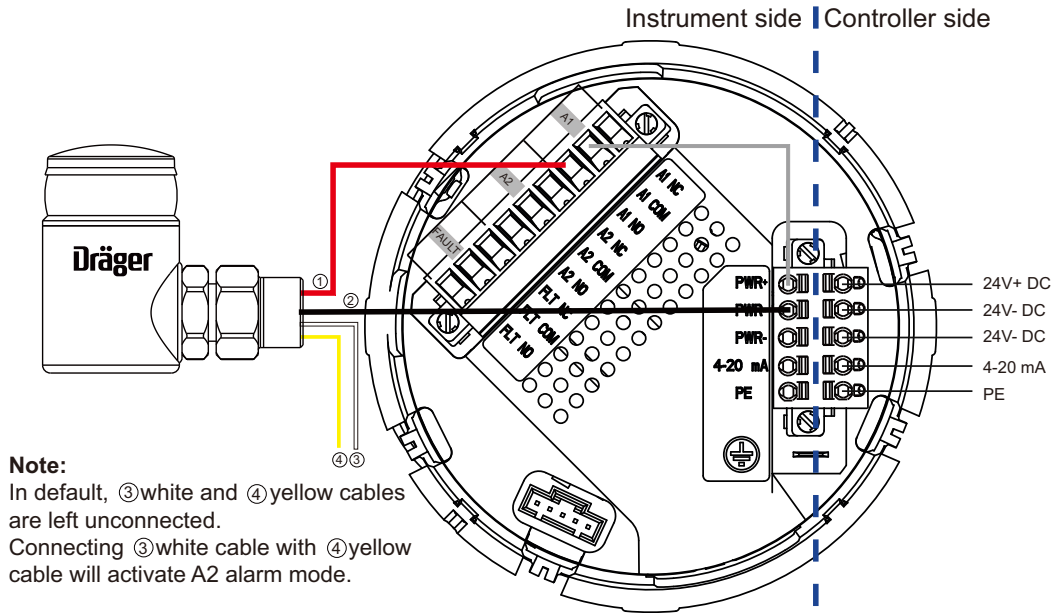

Dräger Detector Display Panel connecting Audio Lamp

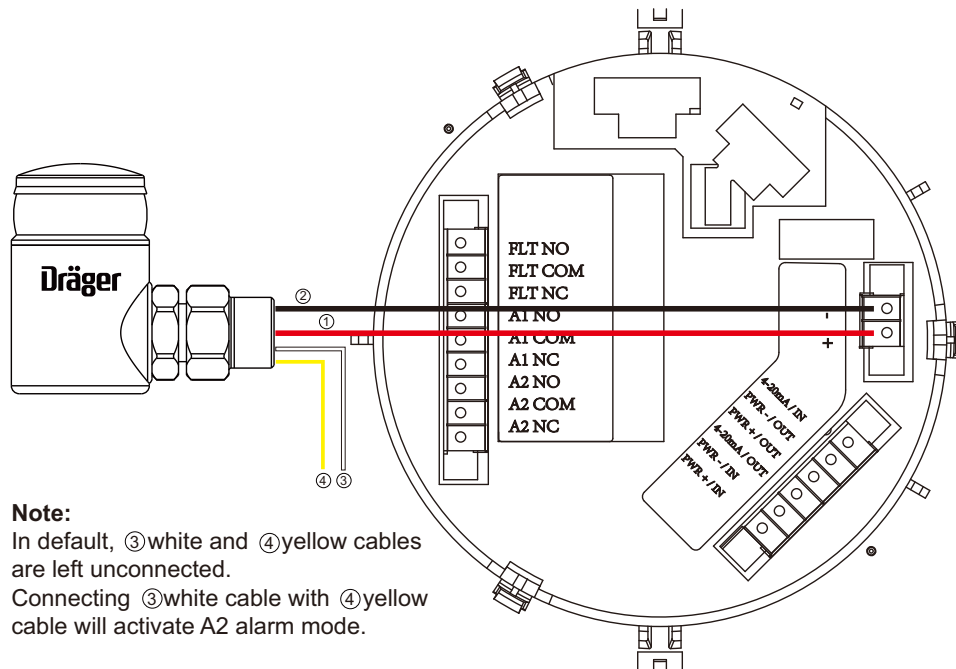

3 Order List

| Order Number | Description |
|--------------|---|
| AH01363 | Dräger Audio Lamp, 304 stainless steel, red lamp |
| AH01372 | Dräger Audio Lamp, 304 stainless steel, blue lamp |
| AH01433 | Dräger Audio Lamp, 316 stainless steel, red lamp |
| AH01434 | Dräger Audio Lamp, 316 stainless steel, blue lamp |
| AH01025 | NPT adapter |
| AH01373 | T-piece connector |